

Management of A MEASLES EPIDEMIC

Practical guide for doctors, nurses, laboratory technicians, medical auxiliaries and logisticians

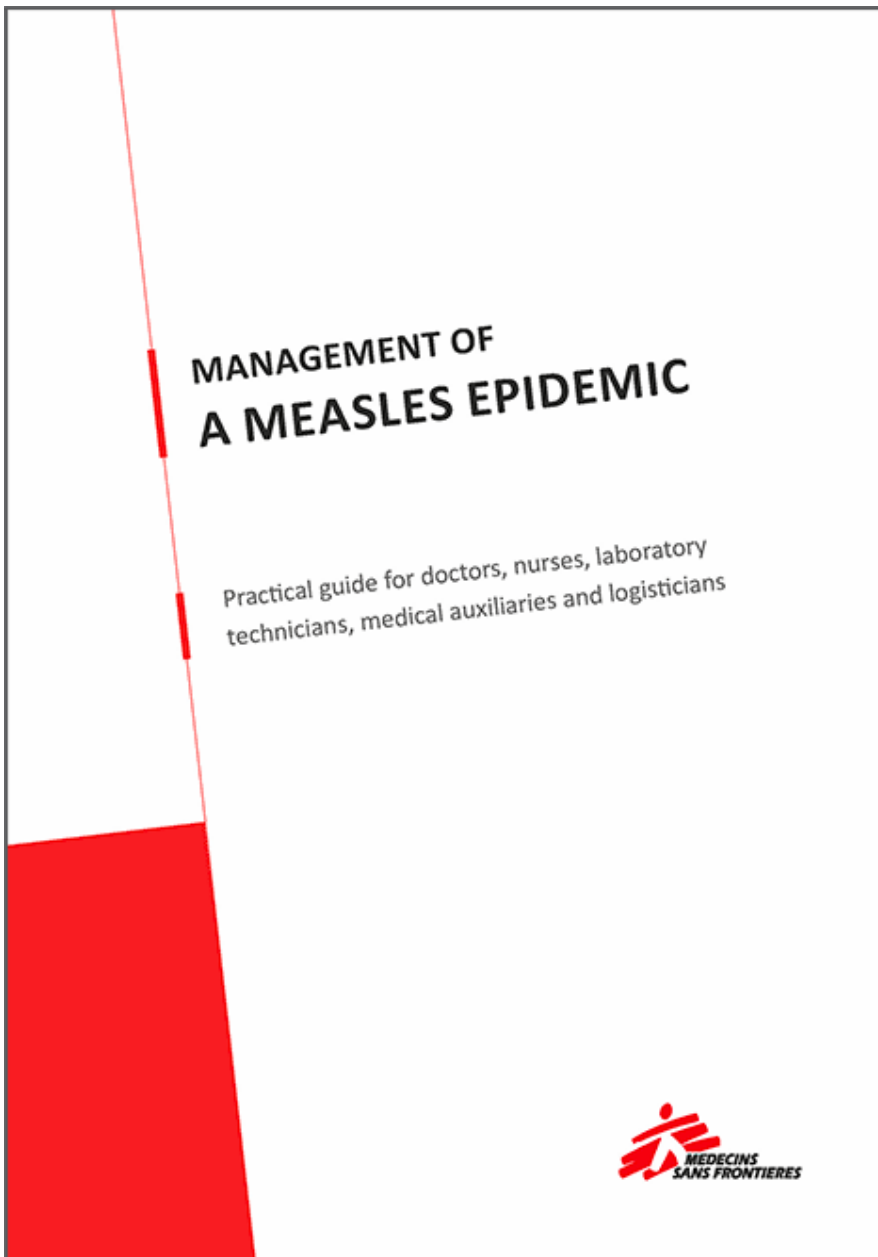

© Médecins Sans Frontières

All rights reserved for all countries. No reproduction, translation and adaptation may be done without the prior permission of the Copyright owner.

Médecins Sans Frontières. Management of a measles epidemic.

2013 Edition

ISBN 978-2-37585-025-1

Table of contents

[Authors/Contributors](#)

[Preface](#)

[Abbreviations and acronyms](#)

[Chapter 1: Characteristics of measles](#)

[Chapter 2: Measles vaccination](#)

[Chapter 3: Investigating a measles outbreak](#)

[Chapter 4: Outbreak management](#)

[Chapter 5: Case management](#)

[Chapter 6: Mass vaccination campaign](#)

[Chapter 7: Activity monitoring and evaluation](#)

[Chapter 8: Outbreak preparedness](#)

[Appendices](#)

[Toolbox](#)

[Film: Organising an emergency mass vaccination campaign](#)

Authors/Contributors

Authors

Corinne Danet
Florence Fermon

Technical editors

Catherine Bachy
Véronique Grouzard

Contributors

Olivier Blanchet, Laurence Bonte, Marie-Eve Burny, Bertrand Draguez, Rebecca Grais, Myriam Hens, Northan Hurtado, Céline Lastrucci, Aurélie Lava, Richard Murphy, Klaudia Porten, Jean Rigal, Myrto Schaefer, Elisabeth Szumilin, Aurore Taconet, Joos Van den Noortgate.

We thank the teams in the field who, by sharing their experiences, contributed to this guide.

Translation

Nina Friedman
Véronique Grouzard

Published by

Médecins Sans Frontières

Preface

Despite immunisation programmes, measles remains a significant public health problem in many countries. While developed countries still have occasional outbreaks, it is in low-income countries that the virus continues to cause recurrent large-scale epidemics with very high death tolls, especially among children.

Inadequate access to health care and the decline in expanded programmes on immunisation and their funding are responsible for numerous missed opportunities to vaccinate. In addition, conflict-generated population displacements and epidemiological surveillance failures contribute to the continued spread of the virus and the resurgence of outbreaks in developing countries.

This guide is intended for medical and non-medical personnel involved in monitoring and managing epidemics at every level of the health care system. We have tried to respond in the most practical way possible to the problems faced by staff, using the recommendations from reference organizations such as the World Health Organization (WHO) and the field experience of Médecins Sans Frontières.

This guide is divided into eight chapters dealing with the epidemiology of the disease, immunisation and its impact and the various components of outbreak response. To facilitate comprehension and activity set-up, practical tools – including procedure sheets (measles diagnosis/treatment, vaccine preparation/storage, etc.), sample forms (laboratory tests, donations), Excel files for surveillance, needs estimation (cold chain, treatments, vaccines and medical supplies, etc.) and activity monitoring/evaluation, and a film on the organization of a vaccination campaign – are provided in the Appendices and on the Toolbox.

Despite all efforts, it is possible that certain errors may have been overlooked in this guide. Please inform the authors of any errors detected.

To ensure that this guide continues to evolve while remaining adapted to field realities, please send any comments or suggestions.

As treatment protocols are regularly revised, please check the [updates](#).

Abbreviations and acronyms

ADS	Autodisable syringe
AEB	Accidental exposure to blood
AEFI	Adverse events following immunization
°C	Degree Celcius
ENL	Ear, nose and throat
EPI	Expanded programme on immunization
HIV	Human immunodeficiency virus
IgG	Immunoglobulin G
IgM	Immunoglobulin M
IM	Intramuscular route
IU	International unit
IV	Intravenous route
OR	Odds ratio
ORS	Oral rehydration solution (or salts)
PB	Brachial perimeter
PO	Per os (oral route)
RR	Respiratory rate
RR	Reproduction ratio
RUTF	Ready to use therapeutic food
Rx	Treatment
SC	Subcutaneous route

SIA	Supplementary immunization activities
SpO ₂	Arterial blood oxygen saturation measured by pulse oximetry
VC	Vaccination coverage
VVM	Vaccine vial monitor
W/H	Weight-for-height
WHO	World Health Organization

Chapter 1: Characteristics of measles

[1.1 General points](#)

[1.2 Epidemiology](#)

[1.3 Key points](#)

1.1 General points

Measles is an extremely contagious acute viral infection, characterized by a fever and skin rash with signs of respiratory infection. It mainly affects children. There is no specific treatment for measles.

1.1.1 Scope of the problem

The introduction of an effective inexpensive vaccine in the 1960s helped reduce the scope of the disease on a global level. However, measles is still a major public health problem in countries where low vaccination coverage (in Africa and Asia, mainly) has allowed the disease to persist and give rise to large-scale outbreaks ([Figure 1.1](#)).

In 2010, 181 countries together reported more than 254,000 cases of measles^a. According to the WHO, despite overall improvements in epidemiological surveillance, these figures are probably still greatly underestimated.

Figure 1.1: Incidence rate for reported measles cases per 100,000 people in 2010

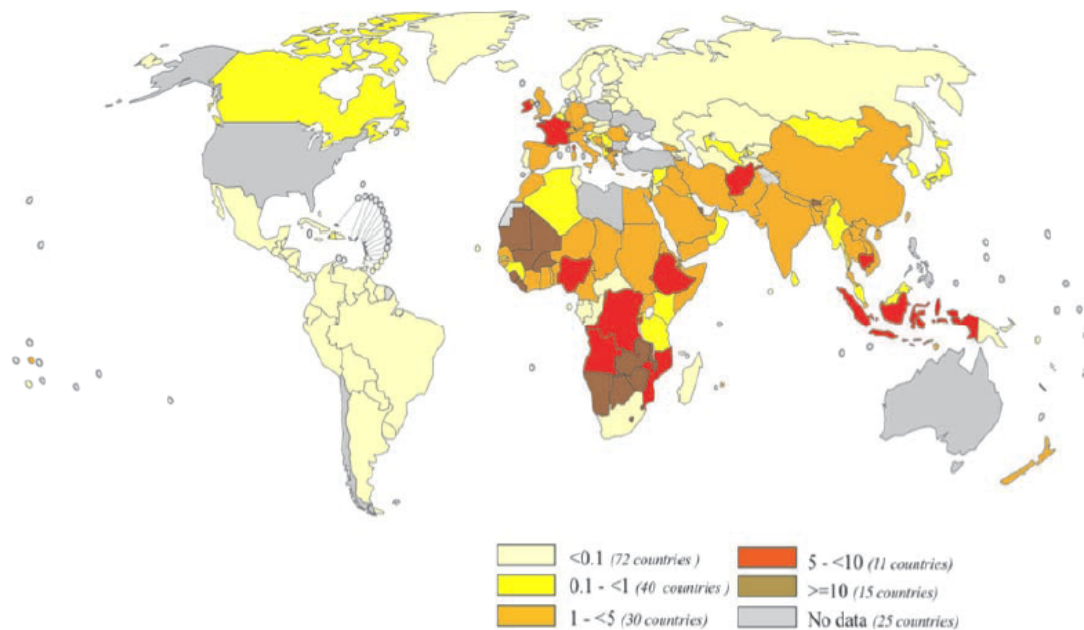

Source: WHO/IVB

1.1.2 Infectious agent

Measles is caused by a paramyxovirus (morbillivirus), whose only reservoir is man (infected individuals, including those who are asymptomatic).

The terms “clade” and “genotype” are used to describe the genetic characteristics of wild viruses.

There are currently eight known clades (designated by the letters A-H) and 22 known genotypes. Their distribution varies by region^{[1] . [2]}:

- In Africa, clades B and D predominate, with several identified genotypes.

- In Southeast Asia, clade D predominates, with numerous genotypes.
- In the Pacific region, there is a wide variety of clades and genotypes.

Molecular characterisation of measles viruses provides a method for identifying their geographical origin and monitoring their spread and any genotype changes. It is essential for documenting the impact of measles programs at the global level.

1.1.3 Transmission

Transmission occurs primarily by direct contact with nasal or throat secretions, by the airborne route and, rarely, by indirect contact.

Viral droplet nuclei shed by the infected individual infect the healthy individual by penetrating the nasal, oral, laryngeal or conjunctival mucosa. The virus can remain suspended in the air for more than two hours, but does not survive long on objects or surfaces.

The contagious period begins three to four days before the rash appears, and continues for up to five days after the rash begins. It can be longer in malnourished or immunodepressed individuals.

1.1.4 Natural immunity

Immunity can be acquired naturally (by contracting the disease) or by vaccination.

In infected individuals, IgM antibodies are detectable as soon as the rash appears and persist for about a month. IgG antibodies appear a few days later and are detectable for life. Natural infection therefore confers lifelong protection.

The virus is eliminated by activation of the immune response. Paradoxically, that activation provokes temporary immunodepression, which lasts from 1 to 6 weeks after the rash appears^[3] and causes most measles-related infectious complications and deaths.

1.1.5 Vulnerability

Maternal antibodies, transmitted via the placenta and breast milk, protect infants for the first few months of life and then gradually disappear around age 5 to 12 months.

Once these antibodies have disappeared, all children become “susceptible,” that is, at risk of developing the disease if infected.

It is estimated that in an unvaccinated population, nearly all children will develop measles before adolescence. While the age of occurrence is determined by the probability of contact with an individual that has measles, children under 5 years – and more specifically, under 3 years – are usually affected most.

When vaccination is administered, a small percentage of those vaccinated fail to develop immunity (vaccine efficacy 80-95%). Those individuals will not be protected by the vaccine, and will be at risk of developing the disease if infected.

1.1.6 Case fatality rate (CFR)

In industrialised countries, the case fatality rate is low and the disease often wrongly considered benign. The WHO estimates that 4% of deaths in children under age 5 years worldwide are attributable to measles^[4], and that 90% of measles-related deaths are in children under age 5 years.

During outbreaks in developing countries, the overall CFR (both early and late) can range from 3 to 15%. In emergency settings (refugee camps, displaced populations, etc.), in areas where the prevalence of acute malnutrition is high, and in poor urban areas, it can be over 20%^[5].

The early CFR (< 30 days) varies from 1 to 5%^[6], and the hospital mortality from 6 to 34%^[7], depending on the context.

The risk factors for death are:

- age less than 3 years;
- acute malnutrition;
- vitamin A deficiency;
- immune deficiency.

Three recent retrospective measles mortality surveys^[6] confirmed that the CFR for children under 5 years was markedly higher than for older children (Figure 1.2). In urban settings, the CFR was highest in children under 1 year and decreased with age. The CFR in rural settings was higher than in urban settings for all age groups. The CFR found by the surveys was higher everywhere than previously reported, because the majority of deaths that occurred at home had not been counted.

Figure 1.2: Measles case fatality rate by age group at three sites: Boukoki (urban area, Niger), Moursal (urban area, Chad), and Dong (rural area, Nigeria)

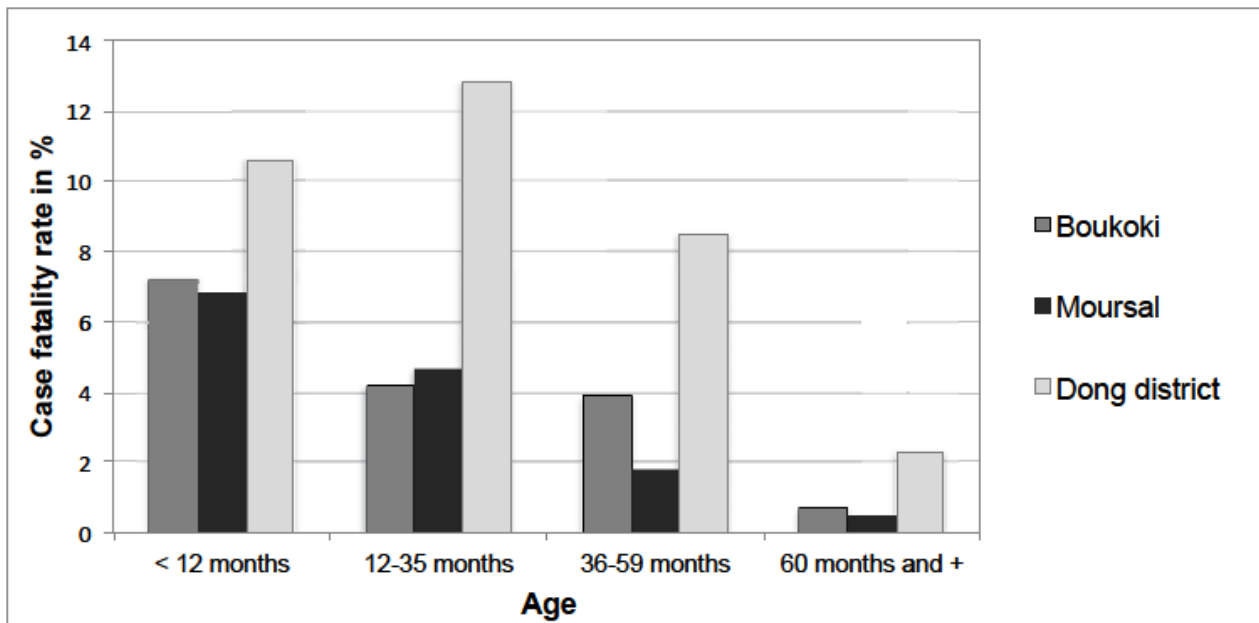

Source: Epicentre/MSF

Footnotes

(a) For the most recent data, see the site:

http://www.who.int/immunization_monitoring/diseases/measlesregionalsummary.pdf

References

1. Weekly epidemiological record. No. 51/52, 2006, 81, 469–480.
<http://www.who.int/wer/2006/wer815152.pdf>
2. Weekly epidemiological record. No. 9, 2012, 87, 73–80
<http://www.who.int/wer/2012/wer8709.pdf>
3. Speziani C, Laine D, Servet-Delprat C, Valentin H, Rabourdin-Combe C. *Virus de la rougeole et immunosuppression*. Med Mal Infect 2004 ; 34 (s1) 2-6.
4. World Health Organization. *The global burden of disease: 2004 update*. 2004. WHO Press, Geneva 27, Switzerland, World Health organization WHO.
http://www.who.int/healthinfo/global_burden_disease/GBD_report_2004update_full.pdf
5. Wolfson LJ, Grais RF, Luquero FJ, Birmingham ME, Strebel PM. *Estimates of measles case fatality ratios: a comprehensive review of community-based studies*. Int J Epidemiology. 2009;38:192–205.
6. Grais RF, Dubray C, Gerstl S, Guthmann JP, Djibo A, Nargaye KD, Coker J, Alberti KP, Cochet A, Ihekweazu C, Nathan N, Payne L, Porten K, Sauvageot D, Schimmer B, Fermon F, Burny ME, Hersh BS, Guerin PJ. *Unacceptably high mortality related to measles epidemics in Niger, Nigeria, and Chad*. PLoS Med. 2007 Jan;4(1):e16.
7. Malfait P, Jataou IM, Jollet MC, et al. *Measles epidemic in the urban community of Niamey: transmission patterns, vaccine efficacy and immunization strategies, Niger, 1990 to 1991*. Pediatr Infect Dis J 1994; 13:38-45.

1.2 Epidemiology

1.2.1 Incidence and vaccination

According to the WHO, worldwide measles vaccination coverage in 2011 had reached 84% (Figure 1.3)^a. However, only 65% of the world's countries had achieved vaccination coverage equal to or greater than 90%.

Figure 1.3: Annual measles incidence and worldwide vaccination coverage, 1980-2011

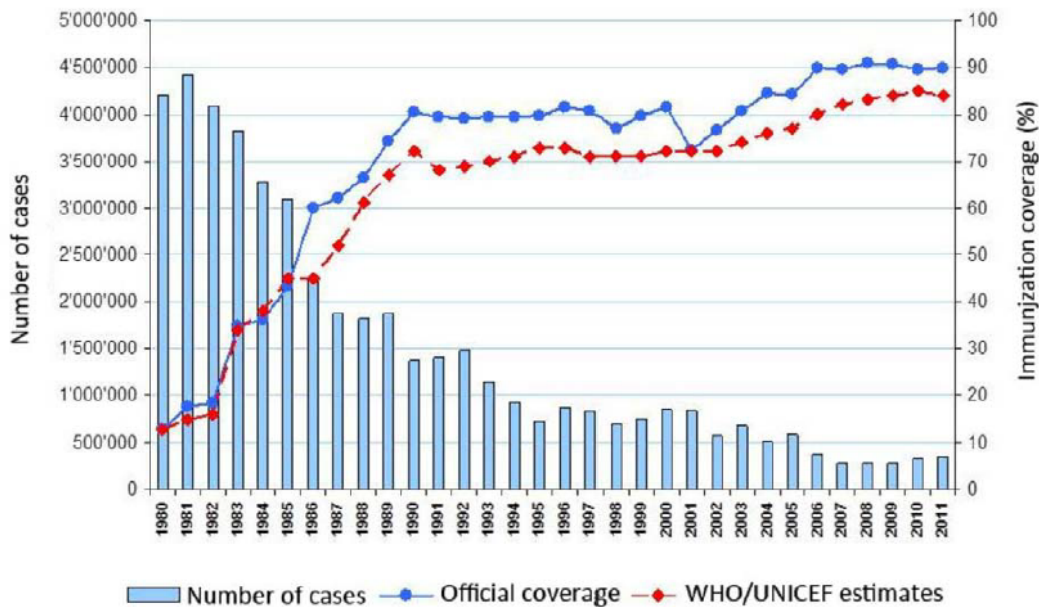

Source : WHO/IVB

Vaccination helps control measles and changes the epidemiology of the disease.

Those changes are due to:

- The vaccine's mechanism of action: the vaccine protects individuals from infection; it reduces the number of susceptible individuals and, as a result, transmission of the virus.
- Vaccination coverage: when more than 90% of the population is immunised, transmission is reduced and the risk of exposure to the virus is low for the whole population. This is known as community, or herd, immunity; non-immunised people are protected by the size of the immunised group around them.

High vaccination coverage will:

- reduce the measles incidence and mortality rate;
- reduce the group of susceptibles;
- increase the proportion of immunised people among the cases;
- alter the age distribution of cases;
- increase the time between outbreaks.

Incidence, mortality and time between outbreaks

When vaccination coverage increases and stays at a high level, there is a decline in the incidence and more widely-spaced outbreaks. Only maintaining very high vaccination coverage (over 95%) can prevent outbreaks.

The figure below shows schematically how the measles incidence and risk of an outbreak vary as a function of vaccination coverage obtained by primary vaccination (one dose starting at age 9 months).

Figure 1.4: Vaccination coverage, incidence, and time between outbreaks

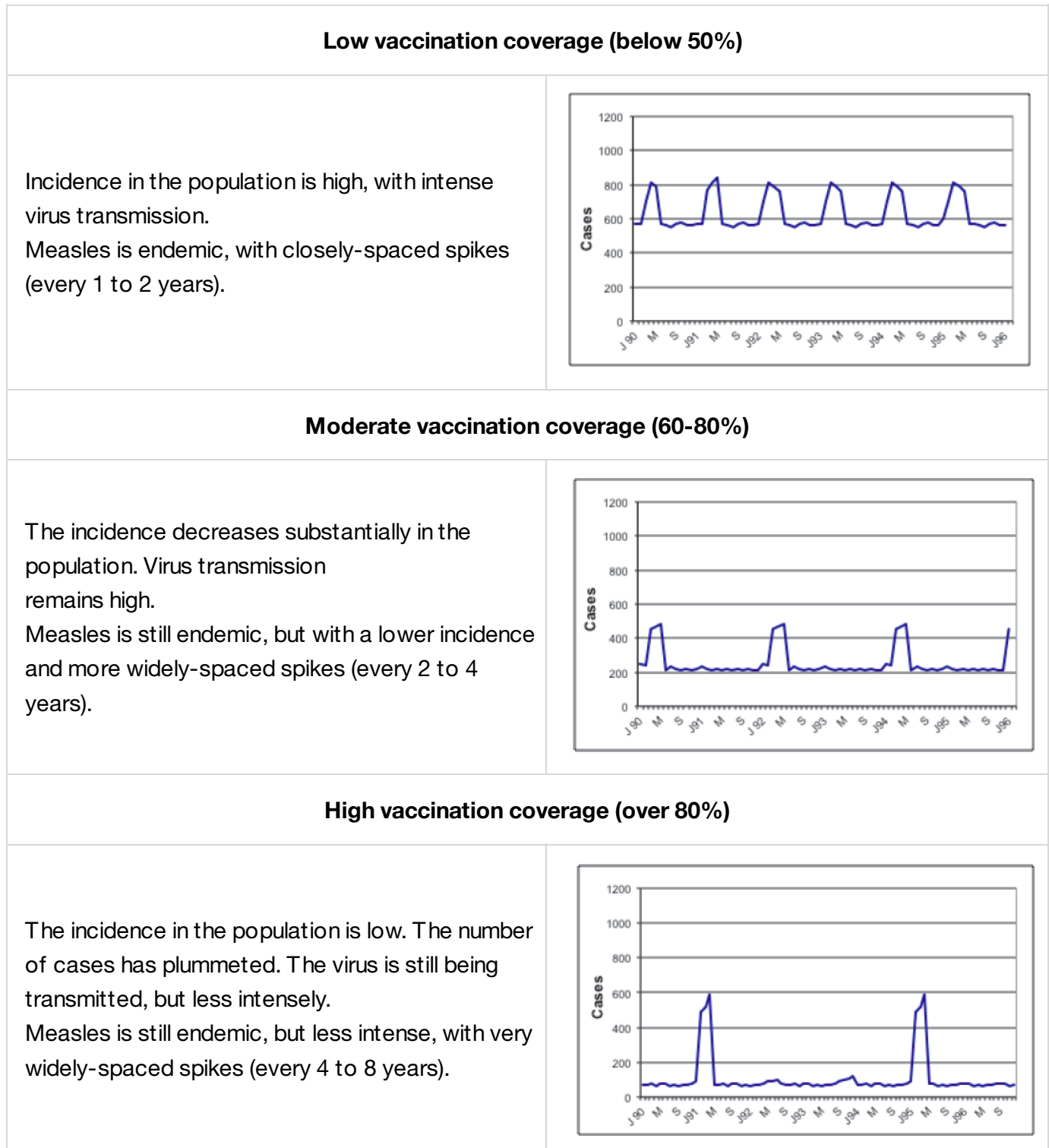

The group of susceptibles

This group includes unvaccinated people and people who did not respond to vaccination (the protection conferred by a single dose of vaccine administered starting at age 9 months ranges from 80 to 95%, depending on the study).

Example: Estimating the number of susceptibles in a population of **110,000 children** under age 5 years

<i>Vaccination coverage 90%</i>	<i>10% unvaccinated11,000</i>
<i>Vaccination efficacy 90% (99,000 vaccinated)</i>	<i>10% non-responders9,900</i>
	<i>Total susceptible.....20,900</i>

If measles immunisation activities remain steady in a population (one dose for children ages 0-11 months) and achieve 80% coverage, that means that each year, the unprotected portion of the 0-11 month-olds for that year are added to the susceptibles already present in the population.

If there is no additional immunisation activity (administration of a second dose and/or vaccination campaign), the virus will continue to circulate in the population, but transmission will be low and few cases will occur.

The number of susceptibles will continue to build from year to year, until it reaches some critical mass. There will then be a significant increase in the number of cases, or even an outbreak affecting the susceptibles in all age groups (including the oldest). If it were a large-scale outbreak, the majority of susceptibles in the population would be infected and would then be immunised. A new group of susceptibles would begin to form from the new births that year ([Figure 1.5](#)).

Figure 1.5: Example of accumulation of susceptibles over several years

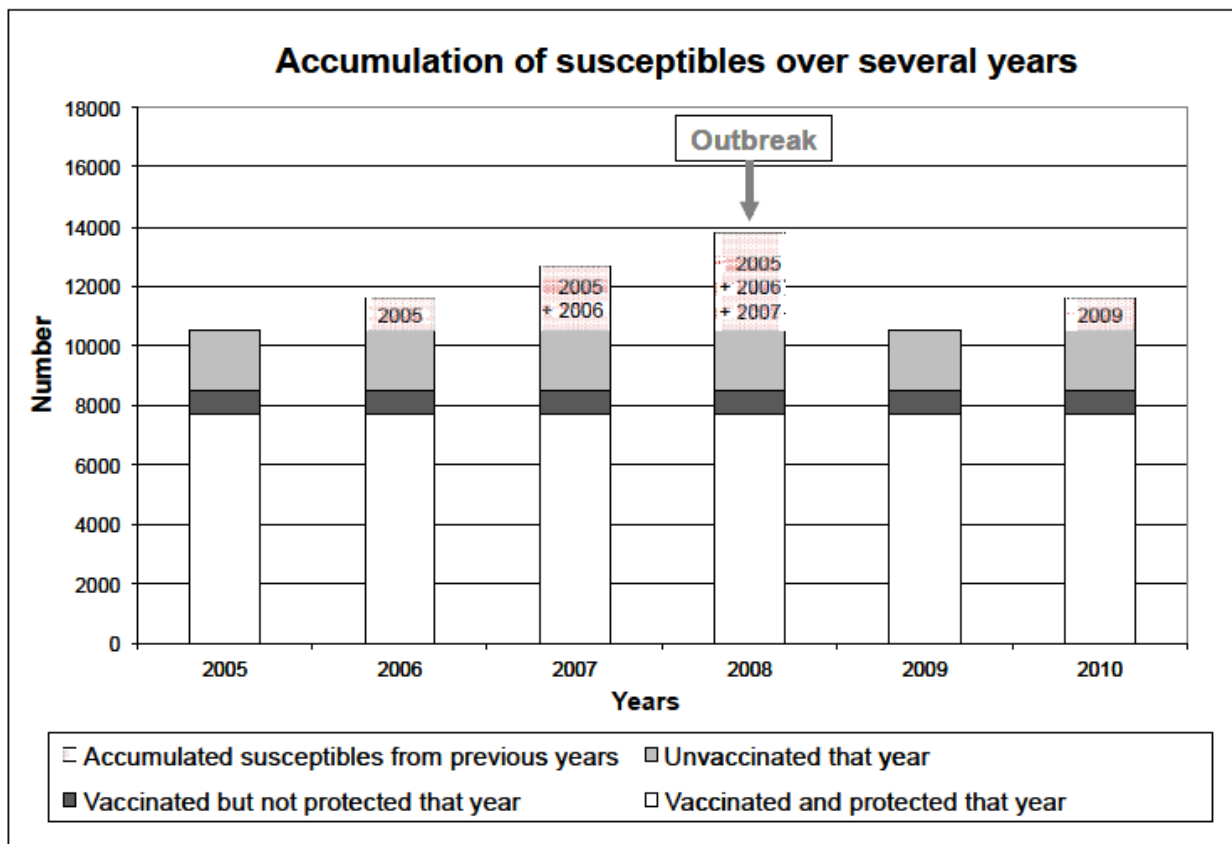

Note: it is assumed that there were no susceptibles from 2004. In 2006, the unprotected fraction of children born in 2005 would join that year's susceptibles (nonresponders and unvaccinated). The number grows in this way from year to year.

Proportion of vaccinated among the cases

Increasing the vaccination coverage leads to a sharp decline in the number of cases. At the same time, however, the proportion of vaccinated among the reported cases grows. Most of those cases are therefore due to vaccine failure.

Example of how the proportion of vaccinated among measles cases varies with vaccination coverages of 40 and 80%:

Assumptions: Annual incidence in unvaccinated children: 50% Annual incidence in vaccinated children: 5%		Vaccination coverage 40%	Vaccination coverage 80%
Total number of children		100,000	100,000
Unvaccinated	Number of children	60,000	20,000
	<i>Number of cases</i>	<i>30,000</i>	<i>10,000</i>
Vaccinated	Number of children	40,000	80,000
	<i>Number of cases</i>	<i>2,000</i>	<i>4,000</i>
Total number of cases		32,000	14,000
Proportion of vaccinated among the cases		6.3%	28.6%

1.2.2 Risk factors for an outbreak

It is important to clearly identify the risk factors for outbreaks and prioritise prevention and response activities. The risk factors have to do with the size of the at-risk group and the frequency of exposure to the virus.

Size of at-risk group

- If the birth rate is high ($\geq 4\%$), the proportion of children (and thus the size of potential susceptibles group) is large.
- If the vaccination coverage is too low, the number of susceptibles will continue to accumulate from year to year, rapidly reaching critical mass.

Frequency of exposure to the virus

The higher the population density, the greater the number of people exposed to an intense transmission focus, due to crowding. The risks are higher for:

- people living in poor urban settings;
- displaced or refugee populations;
- people in contact with a case in health care facility waiting rooms (poor ventilation, people gathered together and the presence of measles cases);
- people in institutional settings (paediatrics departments, schools, orphanages, feeding centres, prisons, etc.);
- a sick child's family members (household transmission).

When access to care is poor, fewer children are vaccinated (reduced access to vaccination) and measles is diagnosed later (more people at risk of contact with the patient).

1.2.3 Description of outbreaks

Seasonality and spread

In tropical areas, transmission increases at the end of the rainy season and intensifies throughout the dry season.

In temperate areas, cases typically occur at the end of winter and beginning of spring.

Classically, the disease spreads from high population density to low population density areas.

In rural settings, where transmission is lower, epidemic outbreaks are generally localised, more widely spaced and smaller in scale than in urban settings.

Duration and size

Outbreaks can last anywhere from a few weeks to several months.

A study on five urban outbreaks where there was no early intervention showed (Figure 1.6) outbreaks lasting longer than six months, and a widely-varying number of cases (from 2,500 to more than 53,000).

Figure 1.6: Duration and size of outbreaks; some examples

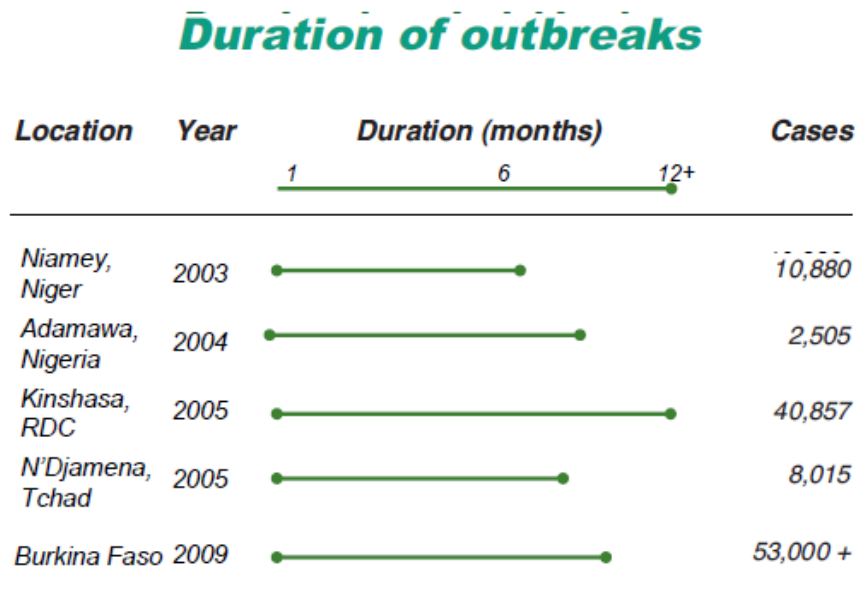

The duration and size of outbreaks are related to:

- the size and density of the exposed population;
- how fast the disease spreads;
- the prior vaccination coverage and the size of the susceptible cohort;
- how fast outbreak response vaccination is put in place.

Speed of spread

The reproductive ratio (RR) is the average number of secondary measles cases produced from one source case. It is the indicator that allows to estimate how fast an outbreak is spreading. A low RR means that the outbreak is moving slowly.

It depends on several factors; the three main factors are:

- the contagious period of the disease;
- the probability of disease transmission at each contact;
- the number of susceptible people in the population.

In a completely susceptible (unprotected) population, one person infected with the measles virus will infect from 12 to 20 people^[1]. In areas where part of the population has been vaccinated or infected by the virus previously, the RR is lower.

Various studies conducted during African epidemics from 1987 to 2005 have showed RRs ranging from 2.5 to 4.6.

Table 1.1: Measles reproductive ratios determined by studies in three countries

Location and year	Effective RR	Vaccination coverage	
		Before	After
Niakhar ^(a) , Senegal, 1987- 2000 ^[2]	Before vaccination: 4.6	No vaccination	38%
	After vaccination: 3		
Niamey, Niger, 2003-2004 ^(b)	2.8	60% (6-59 months)	70% (6-59 months)
N'djamena, Chad, 2005 ^(b)	2.5	33% (6-59 months)	80% (6-59 months)

(a) Rural endemic zone, primary vaccination during successive mass immunisation campaigns

(b) Vaccination coverage by survey (card or history)

Source: *Epicentre/MSF*

Impact of outbreak response vaccination

Modelling studies on the impact of vaccination during outbreaks in endemic areas from 1995 to 2006 showed that outbreaks lasted longer without outbreak response vaccination. In those contexts, because the disease was spreading slowly (low RR), even late vaccination helped prevent a large number of cases^{[3][4][5][6]}.

The two graphs below show the proportion of cases avoided in children ages 6 to 59 months ([Figure 1.7](#)) and 6 months to 15 years ([Figure 1.8](#)), as a function of the time to implement vaccination.

Figure 1.7: Percentage of cases avoided as a function of vaccination coverage and time to vaccination in children ages 6-59 months, Niamey, Niger, 2004

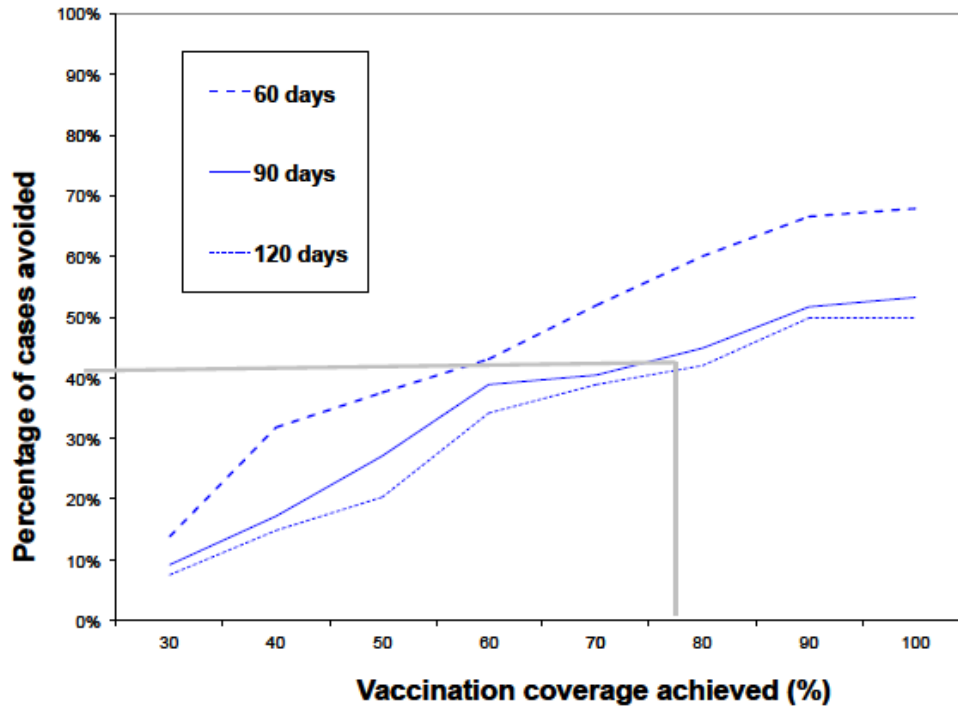
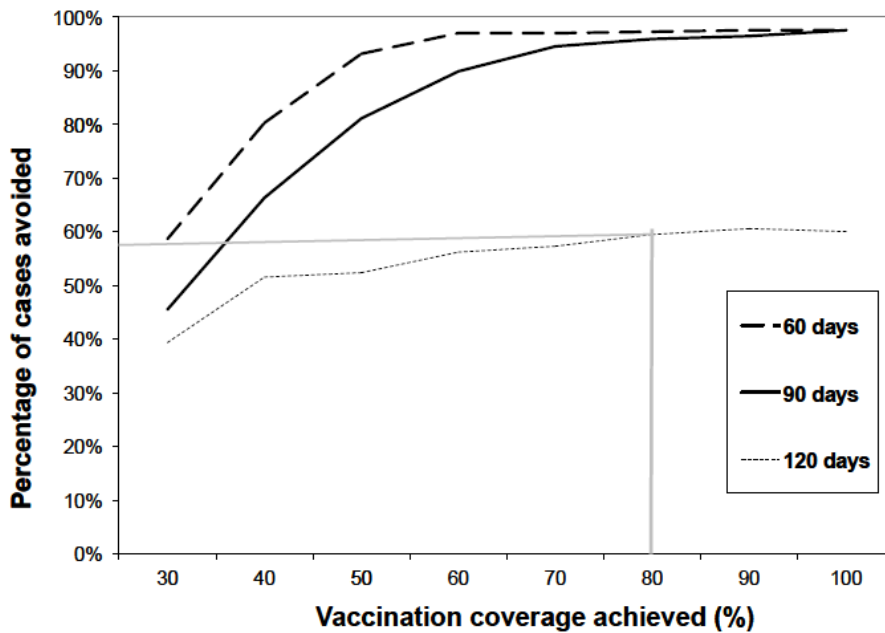

Figure 1.8: Percentage of cases avoided as a function of vaccination coverage and time to vaccination in children ages 6 months-15 years, Niamey, Niger, 2004



Source: Epicentre/MSF

An analysis of Figures 1.7 and 1.8 shows that a vaccination campaign conducted **120 days** after the start of the outbreak with 80% vaccination coverage prevents approximately:

- 40% of cases if children under 5 years are vaccinated (Figure 1.7);
- 60% of cases if children up to 15 years are vaccinated (Figure 1.8).

The same intervention at **60 days** would have prevented approximately:

- 60% of cases if children under 5 years were vaccinated (Figure 1.7);
- 95% of cases if children up to 15 years were vaccinated (Figure 1.8).

The models show that a vaccination campaign that is started early, targets children up to age 15 years, and achieves a high vaccination coverage helps avoid a very large number of cases.

In practice, the decision regarding which age groups to vaccinate has to be carefully weighed according to the available epidemiological data and the resources that can be mobilised.

Two examples of measles outbreaks and vaccination responses are presented in [Appendix 1](#).

Footnotes

(a) For the most recent data, see the site:

http://www.who.int/immunization_monitoring/diseases/measles/en/index.html

References

1. Grais R.F., et al. *Estimating transmission intensity for a measles epidemic in Niamey, Niger: lessons for intervention*. Transactions of the Royal Society of Tropical Medicine and Hygiene, 2006. 100(9): p. 867-873. <http://ento.psu.edu/publications/graisetal2006.pdf>
2. Broutin H., et al. *Epidemiological impact of vaccination on the dynamics of two childhood diseases in rural Senegal*. Microbes and Infection, 2005. 7(4): p. 593-599.
3. Ferrari M. J., Grais R. F., Bharti N., Conlan A. J. K., Bjørnstad O. N., Wolfson L. J., Guerin P. J., Djibo A., Grenfell B. T. 2008. *The dynamics of measles in sub-Saharan Africa*. Nature 451, 679–684.
4. Grais RF, DE Radiguès X, Dubray C, Fermon F, Guerin PJ. *Exploring the time to intervene*. Epidemiol Infect. 2006 Aug;134(4):845-9. Epub 2006 Jan 26.
5. Grais RF, Conlan AJ, Ferrari MJ, Djibo A, Le Menach A, Bjørnstad ON, Grenfell BT. *Time is of the essence: exploring a measles outbreak response vaccination in Niamey, Niger*. J R Soc Interface. 2008 Jan 6;5(18):67-74.
6. Dubray C, Gervelmeyer A, Djibo A, Jeanne I, Fermon F, Soulier MH, Grais RF, Guerin PJ. *Late vaccination reinforcement during a measles epidemic in Niamey, Niger (2003-2004)*. Vaccine. 2006 May 1;24(18):3984-9. Epub 2006 Feb 8.

1.3 Key points

- Measles is an extremely contagious viral disease found worldwide.
- It most often affects children under 5 years of age.
- Immunity can be acquired by contracting the disease (lifelong) or by immunisation. One dose of the vaccine administered after age 9 months confers immunity in 80 to 95% of cases.
- The case fatality rate during epidemics is between 3 and 15%.
- The group of susceptibles is composed of unvaccinated individuals and vaccination nonresponders.
- Areas with inadequate vaccination coverage ($\leq 80\%$) or a high birth rate are at high risk for outbreaks.
- In the absence of outbreak response vaccination, outbreaks can last anywhere from a few weeks to several months.
- An early vaccination campaign that targets a broad age range and achieves high vaccination coverage has a significant impact on the shape of the epidemic curve.
- The decision on which groups to vaccinate is based on available epidemiological data and the resources that can be mobilised.

Chapter 2: Measles vaccination

[2.1 Measles vaccine](#)

[2.2 Immunization schedule](#)

[2.3 Immunization strategies](#)

[2.4 Measles control programmes \(WHO/UNICEF\)](#)

[2.5 Key points](#)

2.1 Measles vaccine

For more information, refer to these documents:

- Immunological Basis for Immunization Series Module 7: Measles. Update 2009.
http://whqlibdoc.who.int/publications/2009/9789241597555_eng.pdf
- Weekly epidemiological record. No. 35, 2009, 84, 349–360.
<http://www.who.int/wer/2009/wer8435.pdf>

The measles vaccine is a live, attenuated virus vaccine.

2.1.1 Composition

Most of the vaccines currently in use are derived from the Edmonston strain of the measles virus: Schwarz, Edmonston-Zagreb, AIK-C and Moraten. Vaccines derived from other strains are also available: CAM-70, TD-97, Leningrad-16 and Shanghai-191.

There is no significant difference (in terms of efficacy and adverse effects) between these vaccines, and all strains may be used interchangeably.

The vaccines may contain stabilisers (sorbitol or hydrolyzed gelatine) and a small amount of neomycin, but no thiomersal.

2.1.2 Dose and route of administration

Children under 2 years: 0.5 ml per dose, IM route, anterolateral thigh

Children 2 years and over, adolescents and adults: 0.5 ml per dose, SC route, lateral upper arm

2.1.3 Age and vaccine response

The persistence of maternal antibodies affects the vaccine response. Depending on the titre of passively acquired maternal antibodies, infants are in theory protected until age 6 to 9 months. Children born to mothers who were vaccinated in childhood are not protected for as long as those whose mothers are protected naturally by the disease ([Figure 2.1](#)).

Figure 2.1: Placental transfer and change in antibody titre with age according to mother's vaccination status^[1]

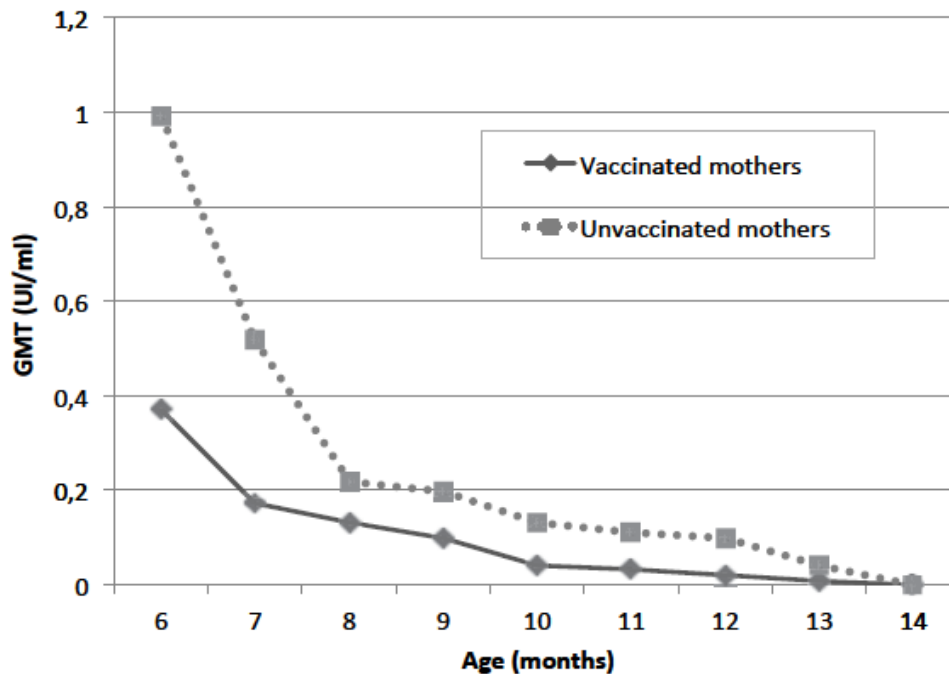

The optimal age for vaccination (first and second doses) varies depending on the local epidemiological situation. It is a trade-off between the child's risk of contracting the illness during the first few months of life and the need to get a high seroconversion rate.

When the first dose of vaccine is administered to children ages 9 to 12 months, the seroconversion rate is about 85%. This increases to 90-95% when children are vaccinated at 12 months. Several studies have tended to show that seroconversion is even higher if the vaccine is administered at 15 months, but does not increase further if the vaccine is administered beyond age 15 months.

Seroconversion appears 10 to 14 days after vaccination, with a peak between the 21st and 28th days.

The protection conferred by primary vaccination lasts several dozen years. Without a second dose the antibody level declines over time, but immune memory persists. When a vaccinated person is exposed to the virus, the immune response is rapidly reactivated.

In order to reduce the number of susceptibles, all children must receive a second dose of vaccine. It is administered after age 1 year, and in most cases allows seroconversion in children who failed to respond to primary vaccination or catch-up for children who never received it.

2.1.4 Contraindications

- History of anaphylactic reaction to any of the vaccine's components (neomycin or gelatine) or to a previous measles vaccine injection.
- Severe immune deficiency (known or clinically suspected):
 - congenital or acquired;
 - HIV infection: children who are symptomatic and/or whose $CD4 \leq 25\%$;
 - leukaemia, advanced lymphoma, or serious neoplastic disease;
 - immunosuppressant drugs (high-dose corticosteroids, antineoplastic chemotherapy, etc.).
- Ongoing severe acute infection. A minor infection is not a contraindication.

2.1.5 Special situations

Malnutrition

Most studies have shown that the immune response to vaccination is the same in normally nourished and malnourished children. Malnutrition increases the risk of contracting the disease and developing severe complications^[2]. Malnourished children are routinely vaccinated in feeding programmes.

Pregnancy

Measles often causes severe complications both for the mother and the foetus (spontaneous abortion) or newborn (congenital measles).

In principle, live vaccines should not be administered to pregnant women. However, during an epidemic in which there are adult cases, the risk/benefit of vaccination should be discussed.

HIV infection^{[3][4]}

All HIV-infected children without severe immune deficiency should be vaccinated as soon as possible.

In immunodepressed children, the first dose of vaccine is administered after immune function is restored (generally after 6 to 12 months of antiretroviral therapy):

- CD4 > 25% in children under 5 years;
- CD4 > 200 in children 5 years and older.

The second dose is administered at least 4 weeks after the first.

Immunoglobulins and other blood products

If a child has received immunoglobulins or blood products 3 to 6 months before vaccination or within 2 weeks after vaccination, administer an additional dose of vaccine 3 to 6 months later.

Prolonged corticosteroid therapy

Patients receiving ≥ 2 mg/kg daily of prednisolone are vaccinated:

- as soon as treatment is stopped if the duration of treatment is < 14 days;
- one month after treatment is stopped if the duration of treatment is ≥ 14 days.

2.1.6 Adverse effects

Adverse effects are generally minor and transient.

- In the first 24 hours, mild pain and tenderness at the injection site.
- 7 to 12 days after vaccination:
 - fever > 39 °C lasting 1 to 2 days in 5 to 15% of cases; the fever can sometimes cause seizures (1/3000);
 - transient skin rash in 2% of cases, sometimes with catarrhal symptoms;
 - rarely: thrombocytopenic purpura (1/30,000 to 1/100,000);

- very rarely: encephalitis (1/1 million).
- Anaphylactic reactions to one of the components of the vaccine: rare (1/20,000 to 1/1 million).

With the exception of anaphylactic reactions, there is a smaller risk of adverse reactions from the second dose.

2.1.7 Combination vaccines and co-administration of multiple vaccines

Combination vaccines

Vaccines come in either monovalent or combined form, that is, associated with other vaccines in the same syringe. The available combination vaccines are:

- MR: measles and rubella;
- MMR: measles, mumps and rubella;
- MMRV: measles, mumps, rubella and varicella.

Co-administration of multiple vaccines

Provided different syringes and different injection sites are used, measles vaccine can be administered at the same time as most other vaccines: DTP, hepatitis B, *Haemophilus influenzae*, oral or inactivated polio, yellow fever, varicella, pneumococcal, meningococcal (polysaccharide AC, conjugate A).

Giving it at the same time as Japanese encephalitis vaccine also appears possible, but further studies are needed to validate this.

To avoid the risk of one immune response interfering with another, different live vaccines should be administered at least four weeks apart.

2.1.8 Vaccine storage

Lyophilised vaccine

To be kept refrigerated between +2 °C and +8 °C. Long term storage in temperatures between -70 °C and -20 °C is possible but is no longer recommended.

Diluent

To be stored at room temperature. However, at least 12 hours before reconstitution, it should be placed in the refrigerator to avoid thermal shock to the lyophilised vaccine (a temperature difference may reduce vaccine efficacy). Do not freeze.

Reconstituted vaccine

The reconstituted vaccine is sensitive to heat and light. It must be kept refrigerated between +2 °C and +8 °C, protected from light, and used within 6 hours after reconstitution.

References

1. Pinquier D., et al. *Distribution of serum measles-neutralizing antibodies according to age in women of childbearing age in France in 2005-2006: impact of routine immunization*. *Pediatr Infect Dis J* 26(8):749-50 (2007).
2. Bhaskaram P. *Measles and malnutrition*. *Indian J Med Res*. 1995 Nov;102:195-9.
3. Scott P, Moss WJ, Gilani Z, Low N. *Measles vaccination in HIV-infected children: systematic review and meta-analysis of safety and immunogenicity*. *J Infect Dis*. 2011 Jul;204 Suppl 1:S164-78. doi: 10.1093/infdis/jir071.
4. Centers for Disease Control and Prevention. *General Recommendations on Immunization. Recommendations of the Advisory Committee on Immunization Practices (ACIP)*. *Morbidity and Mortality Weekly Report*. December 1, 2006 / Vol. 55 / No. RR-15.
<http://www.cdc.gov/mmwr/pdf/rr/rr5515.pdf>

2.2 Immunization schedule

2.2.1 Primary vaccination

In countries where transmission is high and continuous, children should be vaccinated starting at 9 months of age. Any child not vaccinated before age 1 year should be vaccinated as soon as possible.

In countries where transmission is low or nonexistent, primary vaccination is given later, at 12 to 15 months of age.

In certain high-risk situations where children are heavily exposed before 9 months of age, it is recommended that they be given an early dose at or after age 6 months, and then the EPI recommended dose at age 9 months, with at least 4 weeks between the two doses.

These situations include:

- measles epidemics;
- population concentrations (refugee/IDP camps, precarious urban zones);
- paediatric inpatient units;
- children born to HIV-positive mothers (increased risk of severe measles and little protection conferred by maternal antibodies);
- malnourished children (increased risk of complications).

2.2.2 Second dose

The second dose can be:

- administered during follow-up campaigns to children ages 6 months to 5 years (sometimes over age 5 years, depending on the epidemiological situation);

or

- added to the national immunization programme schedule: a second dose at age 15 or 18 months, for example.

2.3 Immunization strategies

2.3.1 Routine vaccination

Measles vaccination is included in all national immunization programmes. Routine vaccination is usually done at fixed sites and outreach sites and by mobile teams.

Fixed site

Regular immunization activities are conducted by the health care facility personnel, who have a refrigerator. This is assumed to cover the population within a radius of 5 km of the fixed site.

Outreach site

Regular and scheduled immunization activities are conducted by health care facility personnel, who travel with a passive cold chain (vaccine carriers). The outreach strategy can cover populations living from 5 to 15 km from the health care facility.

Mobile team

Scheduled immunization activities are conducted by mobile teams that travel around according to a pre-set schedule. Substantial resources are made available for transportation, for vaccine storage (cold boxes and vaccine carriers) and for training the teams. This strategy requires careful organization and informing the remote populations that one wants to reach (> 15 km) beforehand.

2.3.2 Mass vaccination campaign

Vaccination campaigns are one-off activities that allow a large number of people to be immunized in a short period of time by setting up multiple vaccination sites.

They are done as a preventive measure as part of catch-up campaigns or when the risk of an outbreak is high (e.g. displaced populations), or as a response when an outbreak has been detected.

The campaigns mobilise a lot of personnel and resources, and require good coordination between partners.

Catch-up campaign

The purpose of catch-up campaigns is to give children a second dose of vaccine and to “catch up with” children who did not receive routine vaccination. They are scheduled and conducted every 2 to 4 years as part of the international measles control programme.

Outbreak response campaign

The outbreak response campaign is one component of epidemic management. Its aim is to limit the spread of the epidemic by vaccinating the entire at-risk population as quickly as possible.

2.4 Measles control programmes (WHO/UNICEF)

EPI primary vaccination alone cannot control the disease. Additional specific immunization activities are essential.

2.4.1 Control

Control is the first step in any vaccination programme. Its aim is to reduce disease morbidity and mortality (the number of cases and the number of deaths).

In particular, control is the objective of mass vaccination campaigns conducted during population influxes (IDPs/refugees) or in response to an outbreak.

Control strategies have four components:

- improving patient management;
- increasing routine vaccination in order to attain primary measles vaccination coverage $\geq 90\%$ in children under 1 year;
- administering a second dose of vaccine during supplementary immunization activities (SIAs): an initial catch-up campaign to eliminate measles susceptibility in the population (objective: $\geq 95\%$ coverage in children ages 6 months to 15 years), then follow-up campaigns to vaccinate all children born since the last SIA (objective: $\geq 95\%$ coverage in children ages 6 to 59 months). The interval between these campaigns should be adjusted according to the epidemiological situation (from 2 to 4 years);
- increasing surveillance and assessing the impact of activities in order to fine-tune the strategies.

Rapid outbreak response vaccination was added to the control strategy arsenal in late 2011.

2.4.2 Elimination

Elimination strategies aim at stopping circulation of the virus in a large geographic area. While there are no more cases, the risk of reintroduction of the virus makes maintaining very high immunization coverage crucial.

Elimination relies on four activities:

- improving treatment of cases, including routine administration of vitamin A;
- setting up surveillance for each suspected case: investigation and laboratory confirmation;
- maintaining a routine primary measles vaccination coverage $\geq 95\%$ in children less than 1 year;
- offering a second chance for vaccination (SIA) to keep the cohort of susceptibles below the critical threshold.

Countries who resort to regular SIAs to achieve a high level of immunity in the population should not consider ending these SIAs before routine administration of two vaccine doses reaches a coverage of at least 90 to 95% nationally.

2.4.3 Eradication

Eradication means a complete end to transmission of the wild virus in the world. There are no more cases or transmission, and immunization activities can be stopped. This final phase cannot be implemented until the virus has been successfully eliminated worldwide.

2.5 Key points

- The measles vaccine is a live attenuated virus vaccine.
- There are few absolute contraindications to the vaccine, and the adverse effects are generally minor and transient.
- Seroconversion appears 10 to 14 days after vaccination.
- The seroconversion rate after one dose of vaccine ranges from 85 to 95%, depending on the age at administration.
- Measles vaccination is included in all national immunization programmes.
- Vaccination should be done early (starting at age 9 months). Any child not vaccinated before 1 year of age should be protected as soon as possible.
- In certain high-risk situations (malnutrition, HIV infection, population displacement, etc.), it is recommended that children be vaccinated starting at age 6 months and given a second dose at age 9 months.
- Administering a second dose of measles vaccine and getting high immunization coverage are essential to avoiding outbreaks.

Chapter 3: Investigating a measles outbreak

[3.1 Analysing the context](#)

[3.2 Investigating the outbreak](#)

[3.3 Confirming the outbreak](#)

[3.4 Estimating the severity and potential for spread](#)

[3.5 Analysing the initial actions taken](#)

[3.6 Initial conclusions](#)

[3.7 The investigation in practice](#)

[3.8 Key points](#)

3.1 Analysing the context

Planning an investigation requires a rapid and complete analysis of the context.

The following information is essential:

- the administrative and health organization of the country;
- security;
- demographic data (including age distribution, if possible);
- climate and seasons;
- maps, including administrative boundaries, towns and villages, locations of health care facilities and main transportation routes;
- Ministry of Health: organizational chart, key people and their contact information;
- national response strategy for the epidemic (if there is one);
- list of partners involved: UN agencies, bilateral assistance programmes, non governmental organizations, etc.;
- procurement: local options, procedure for importing medical supplies and vaccines;
- local events: national or religious holidays, market days, large demonstrations;
- epidemiological situation in neighbouring countries;
- perception of immunisation among the population.

3.2 Investigating the outbreak

The aim of the investigation is to collect the data needed to confirm the outbreak and analyse the initial actions taken in response.

The effectiveness of the response (controlling the spread of the outbreak by organising a large-scale vaccination campaign) depends primarily on how quickly the outbreak is identified.

The investigation must therefore start at the first warning signs, i.e., an increase in the number of cases compared to the same period in previous (non-epidemic) years.

In principle, if the epidemiological surveillance system is functional and responsive, the alert will be issued as soon as the first cases appear.

3.2.1 Defining cases

The description of an outbreak rests on the case definition. The case definition should be clear, simple and standardised, so that it can be used at all levels from health post to hospital. It should remain constant for the duration of the outbreak. Standardisation allows uniform data collection, i.e., the number of cases and deaths, the age groups at risk and the geographic extent.

The following (WHO-recommended) case definitions are given as an illustration:

<p>Suspected case</p>	<p>Any person in whom a clinician suspects measles infection OR Fever $\geq 38\text{ }^{\circ}\text{C}$ AND Generalised maculopapular rash (non-vesicular) AND One of the following signs: cough or coryza or conjunctivitis</p>
<p>Probable case</p>	<p>Suspected case AND Recent contact with a laboratory-confirmed case</p>
<p>Confirmed case</p>	<p>Suspected or probable case AND Laboratory confirmation:</p> <ul style="list-style-type: none"> • serum antibodies > 3 times the normal or presence of IgM antibody (demonstrates recent infection by the virus) • viral antigen detected by immunofluorescence in nasopharyngeal secretions • positive viral culture

All case definitions are a compromise. A sensitive but relatively nonspecific definition will include all of the cases, but will also include patients who are not cases (overestimation).

Conversely, if the definition is highly specific, all cases counted will be true cases, but some true cases will not be included (under estimation).

3.2.2 Confirming the diagnosis

Most of the time, the diagnosis is clinical (based on the definition of a suspect case).

Prior to the eruptive (rash) phase, suspicion of the disease is based only on contact with a patient and no past history of measles. After the eruptive phase, it requires a differential diagnosis from other febrile eruptive illnesses and drug reactions ([Chapter 5](#)).

Laboratory confirmation

Laboratory testing is crucial to confirm an outbreak, but inability to get laboratory confirmation must not delay outbreak management.

Specimen collection equipment should be made available at all levels (hospitals, health facilities, etc.) at the start of the high-risk season, so that samples can be taken at the first contact with the patient.

At a minimum, specimens should be collected on the first five to ten reported cases in an affected geographic area.

Serological testing for IgM antibody is most sensitive if done between the 3rd and 28th day after onset of the skin eruption. It should therefore be done during that period, if possible. After labelling the tube and completing the sample register ([Appendix 2](#)), quickly send the tube to the laboratory, accompanied by a completed information form ([Appendix 3](#)).

Follow the specimen collection procedures recommended by the country's Ministry of Health.

There are three possible methods for collecting specimens^[1] ([Appendix 4](#)):

- collecting capillary blood, dried, on filter paper;
- swabbing the oral mucosa (between the gum and the tooth) using a small sponge;
- collecting whole blood or serum by venipuncture.

For simplicity and safety, dried blood samples or oral fluid swabs are preferred to serum, because:

- they have nearly equivalent sensitivity and specificity for detection of specific IgM antibodies;
- they do not require venipuncture;
- they permit IgM detection and strain identification;
- the samples are stable for about 7 days without a cold chain.

The result is:

- positive if there is > 20% difference between the levels of measles-specific IgM antibodies and the control;
- negative if the difference is < 10%;
- invalid (equivocal) if the difference is between 10 and 20%.

During an outbreak, laboratory confirmation testing is done on the first several cases (in each geographic area). Once measles is confirmed, epidemiological surveillance relies on the clinical definition (suspected cases).

3.2.3 Counting cases and deaths

The methods for finding cases will depend on the population in question and the existing surveillance system. Cases are looked for and counted:

- at hospitals, health facilities, dispensaries and feeding centres (counting the cases in the registers) first;
- in schools and other places where there are groups of children;
- more rarely, in the villages, by questioning the village heads and visiting the families of reported cases, or cemeteries.

If health care facilities do not have measles registers, put them in place ([Appendix 5](#)).

For each reported case, collect the following information: name, date of birth (or age, if date of birth unavailable), sex, address, admission date, treatment, outcome (recovery, death, or transfer), vaccination status and, if possible, vaccination date.

To avoid double reporting, it is essential to specify how transferred cases are counted.

Cases are reported from the beginning to the end of the outbreak.

3.2.4 Demographic data

The demographic data provide the denominator needed for calculating several indicators (incidence and attack rate).

Reliable demographic data can be hard to get. Often, there are no public records. Be aware of over- and underestimations, depending on the source.

It is important to get the most accurate possible data. Compare the data from several different sources. Justify the choice of data used, and give the source. There should be consensus among the main partners.

For example, demographic data from an old census can be used by applying the hypothetical annual population growth rate.

Local authorities may have more recent population figures than those available at the national level.

Everyone involved in managing the outbreak must use the agreed-upon population data until the end of the outbreak.

3.2.5 Organizing the data

This is the descriptive stage of the outbreak investigation. The situation is described in terms of time, place, and person.

Time

The data are transferred chronologically from the data collection tables ([Appendix 6](#)) onto a graph.

The epidemic curve obtained represents the distribution of cases by date of diagnosis ([Figure 3.1](#)).

This curve allows confirmation that there is an outbreak. If it is completed on regular basis, it also helps monitor the time course of the outbreak and assess the efficacy of the response.

Figure 3.1: Reported measles cases by week, Malawi, 2010

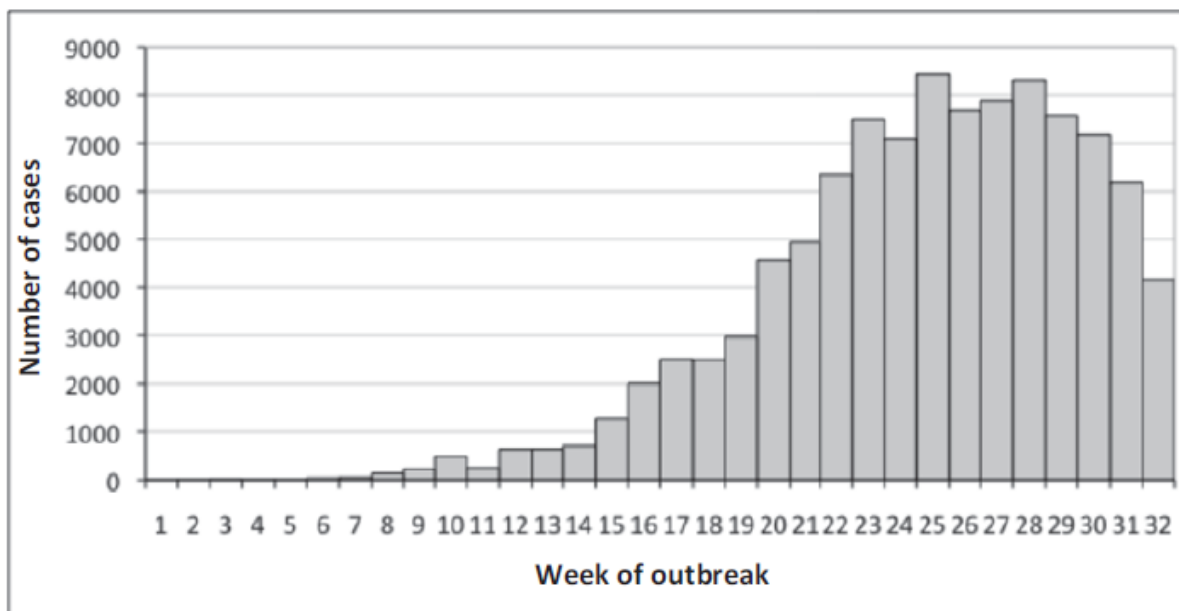

Source: MoH/Epicentre

Place

The geographic distribution of cases or specific attack rates by geographic area (district/ neighbourhood/town or refugee camp section) helps visualise the extent of the outbreak and identify the highest risk areas, in order to set priorities in terms of response.

Figure 3.2: Geographic distribution of measles cases, Week 25, Malawi, 2010

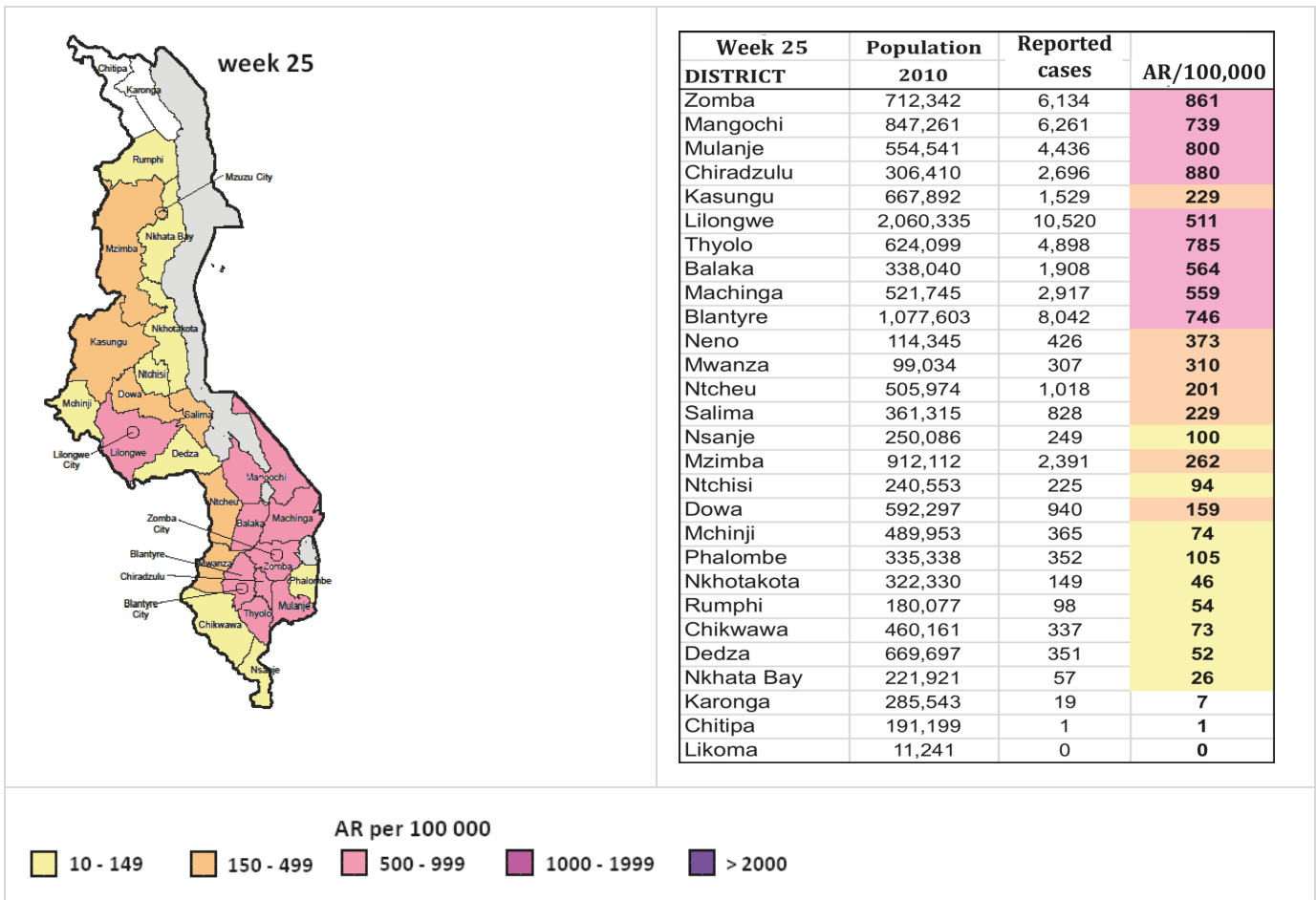

Source: MoH/Epicentre

Person

While it is essential to determine the age of the cases, gender may also be a consideration.

The hardest-hit age groups are identified by calculating the age-specific attack rate. This indicator is critical in defining the target population for the vaccination campaign.

The suggested age groups to look at are 0-5 months, 6-8 months, 9-11 months, 12-59 months, 5-14 years and ≥ 15 years. Depending on the context, it may be necessary to divide the data into other age groups, e.g., 5-9 years and 10-14 years for children and 15-29 and ≥ 30 years for adults ([Figure 3.3](#)).

If the available demographic data do not include the distribution by age group, it is often possible to calculate it from the total population and national data used by other programmes (e.g., EPI). Failing that, use the standard population distribution ([Appendix 7](#)).

Figure 3.3: Measles attack rate by age group, Malawi, 2010

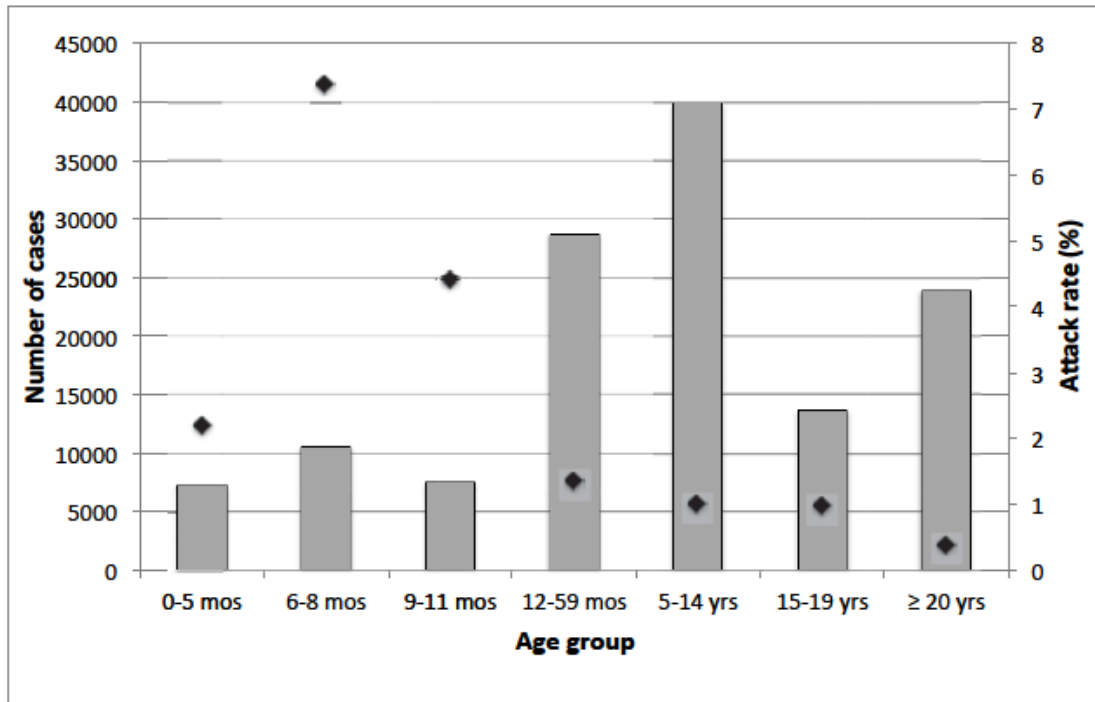

Source: MoH/Epicentre

3.2.6 Analysing the data

Analyse these data to:

- determine the speed with which the outbreak is spreading, and its size (epidemic curve);
- identify the at-risk populations (age groups and place);
- plan and adjust the response, in order to limit the number of deaths and cases and the spread of the outbreak (estimate the needs in terms of treatments, vaccine doses, etc.).

The main indicators to calculate for each level (region, district, town, etc.) are:

- the weekly and cumulative incidence (attack rate);
- the specific attack rate:
 - by location (neighbourhood, health zone, commune, refugee camp zone),
 - by age group (e.g., for a few health facilities).
- the weekly and cumulative case fatality rate:
 - by age group,
 - by treatment site (e.g., in-hospital mortality).

Weekly incidence

This is the speed with which a disease appears in the population during a given period. It is calculated each week during an outbreak.

$$\frac{\text{Number of new cases during the week in question} \times 100,000}{\text{Total population}}$$

Example: in Week 3, there were 85 measles cases reported out of a population of 542,080. The incidence was: $85/542,080 \times 100,000 = 15.7/100,000$.

Attack rate

The attack rate is a particular form of the incidence. It is a cumulative incidence, calculated over a short period of time – since the start of the outbreak, in particular.

$$\frac{\text{Number of new cases during a given period} \times 100}{\text{Population exposed to the risk of the disease during the same period}}$$

Example: there were 3,022 cases of measles reported in children under age 1 year during the four months of the outbreak. There were 20,057 children in that age group (3.7% of the population). The measles attack rate in children < 1 year was: $3,022/20,057 \times 100 = 15.1\%$.

Case fatality rate

The case fatality rate (CFR) is the percentage of deaths among cases of a disease. It is an indicator of the severity of the disease and the quality of patient management.

$$\frac{\text{Number of deaths due to measles in a given place during a given period} \times 100}{\text{Number of measles cases reported in the same place during the same period}}$$

Example: Of the 3,022 cases of measles reported in children under age 1 year, 250 died. 472 of them were treated at the hospital, where 118 of them died:

- The CFR for children under 1 year was: $250/3,022 \times 100 = 8.3\%$
- The in-hospital mortality for children under 1 year was: $118/472 \times 100 = 25\%$

References

1. World Health Organization. *Manual for the laboratory diagnosis of measles and rubella infection*, 2nd ed. CH-1211 Geneva 27, Switzerland (WHO/IVB/07.01).
http://apps.who.int/iris/bitstream/handle/10665/70211/WHO_IVB_07.01_eng.pdf?sequence=1&isAllowed=y

3.3 Confirming the outbreak

An outbreak is suspected when the number of suspected measles cases reported by a geographic unit^a is higher than expected. It must always be confirmed by the laboratory.

In countries that conduct supplementary immunisation activities (SIAs), an outbreak is suspected as soon as the first cases appear. The vaccination coverage and time since the last SIA are taken into account, as shown in the table below.

Table 3.1: Definition of a measles outbreak

	Catch-up campaign completed less than 4 years ago AND vaccination coverage \geq 90%	Catch-up campaign not done OR done 4 or more years ago OR vaccination coverage $<$ 90%
Suspected outbreak	5 suspected cases reported by a single geographic unit in a one month period	Within a geographic unit: <ul style="list-style-type: none"> Number of cases or weekly incidence higher than in previous (nonepidemic) years, or the same as in an epidemic year OR <ul style="list-style-type: none"> If no data from previous years: increase in the number of cases in the last 3 or 4 weeks
Confirmed outbreak	> 2 confirmed cases (IgM+) in a one-month period	

In all countries (whether they have SIAs or not), the onset of an outbreak can be detected by comparing the weekly attack rate to the same period in previous years (epidemic or nonepidemic).

Example: Measles cases and attack rates, 2002-2004, urban area, Niamey, Niger.

Year	Week 1		Week 12	
	Cases	AR/100,000	Cases	AR/100,000
2002	2	0.3	23	3.2
2003	1	0.1	53	6.7
2004	60	7.2	3,832	462.4

Source: SNIS [Système National d'Information Sanitaire du Niger]

In 2004, the number of cases and the attack rate for Week 1 were markedly higher than those in previous years. In Week 12, the number of cases and the attack rate show that there was indeed an outbreak of measles.

In refugee camps and other closed setting (orphanages, feeding centres, prisons, etc.), a single case of measles constitutes an outbreak.

The risk in poor urban areas with low vaccination coverage is similar to that in refugee camps.

Deciding to intervene is always a guess that things will probably progress. If in doubt, however, deciding too soon is better than deciding too late.

Footnotes

(a) A geographic unit may be the area covered by a health post, an administrative region (canton), or a city neighbourhood.

3.4 Estimating the severity and potential for spread

The initial evaluation should provide the information needed to assess the severity of the current outbreak and the risk that it will spread. The choice of response will depend on these data and the resources that can be mobilised. There are several elements to consider.

3.4.1 Surveillance data

- Number of cases, weekly incidence, number of deaths and case fatality rate
- Epidemic curve trend
- Laboratory confirmation
- Surveillance data for the past 5 years
- Information on previous epidemics: date, number of cases and deaths, area and age groups affected and immunisation activities conducted

3.4.2 Population characteristics

- Number of people living in the affected area
- Population density: urban/rural area
- Population movements (seasonal migration, social and religious events)
- Vulnerability of the population: poor urban areas, refugees, internally displaced persons

3.4.3 Size of the susceptible cohort

Two major factors influence the size of the susceptible cohort:

- the size of the birth cohort: this is estimated based on the total population, the expected number of pregnant women and the proportion of live births;
- the vaccination coverage in previous years: routine, SIAs and other activities (e.g., outbreak response vaccination campaign). The coverage figures ordinarily used are based on routine data. Use survey results, if available, because they are often more reliable.

3.4.4 Mortality rate

The case fatality rate and measles-specific mortality rate will depend on the initial health status of exposed population (infant mortality rate, malnutrition) and on access to care (the health system, the drug supply, and the cost of services).

These elements should be considered when organising patient care.

3.4.5 Potential for spread

The potential for spread of the outbreak is based on an evaluation and classification of epidemic risk factors, using a rating scale where + = low risk, ++ = high risk, and +++ = very high risk ([Table 3.2](#)).

Table 3.2: Rating epidemic risk factors

Major risk factors		Risk
Vaccination coverage	≤ 70%	+++
	71-90%	++
	> 90%	+
Number of cases per week in a single geographic area	Continuous (> 4 weeks) and rapid increase	+++
	Increase	++
	Low and stable	+
Laboratory confirmation	≥ 3 confirmed cases	+++
	< 3 confirmed cases	++
	No confirmed cases	+
Comparison of attack rates to the same period in previous years	≥ 10 x or the same as a previous epidemic year	+++
	5 x to 10 x	++
	≤ 5 x or the same as a non-epidemic year	+
Additional risk factors		Risk
Time since the last outbreak	> 4 years	+++
	≥ 2 years	++
	≤ 1 year	+
Population density	Very high	+++
	High	++
	Low	+
Birth rate	Very high (≥ 4%)	+++

	Intermediate (2-3.9%)	++
	Low (< 2%)	+
Existence of an outbreak in an adjacent area		++

The greater the number of risk factors, the greater the threat of spread and a large-scale outbreak. The following table serves as a guide for analysing the potential for the outbreak to spread. A three-level classification scheme is proposed below:

Table 3.3: Potential for a measles outbreak to spread

Potential for occurrence/spread of a measles outbreak		
Low	High	Very high
If the four major risk factors are + and the additional risk factors are low (++ or +).	If one or more of the four major risk factors are ++. Risk increases with increasing number of additional risk factors.	If one or more of the four major risk factors are +++. Risk increases with increasing number of additional risk factors.

3.5 Analysing the initial actions taken

The investigation enables to analyse the initial actions taken.

3.5.1 Surveillance

- Availability and correct use of the case definition, the registers and the data collection forms
- Regular forwarding of the data and weekly analysis
- Means available for laboratory confirmation: sample collection equipment, laboratory capacity, forwarding to a reference laboratory

3.5.2 Outbreak management committee

- Composition, theoretical and actual operating mode, reactivation
- Was the outbreak officially declared?

3.5.3 Patient management

- Availability of, and prescriber adherence to, protocols
- Stock of drugs and medical supplies, orders in progress, procurement strategy (current and anticipated)
- Care conditions, referral arrangements (circuit and conditions)
- Access to care: financial, geographical, around-the-clock, for everyone (excluded groups?), etc.

3.5.4 Vaccination

- Stock of vaccines and vaccination supplies (quantity, strain and expiry date), orders in progress, vaccination strategy (current and anticipated)
- Precise cold chain inventory (existing and available equipment, by type)
- Availability of experienced, trained vaccination teams

3.6 Initial conclusions

When the investigation is over, write an accurate, concise report. It should contain the following elements:

1 - Summary

2 - Introduction

- Quick description of the overall, health and epidemiological context:
 - geographic, administrative, and logistical (access, distances, etc.) information,
 - population data,
 - security, population movements, social events, etc.,
 - health system,
 - epidemiological situation in previous years: cases, deaths, vaccination coverage (EPI and campaigns, specify the target population), dates of most recent outbreaks, and risk factors,
 - succinct description of the surveillance system: case definition, reporting system, data transmission and analysis.

3 - Objectives of the investigation and methods

- How was the alert given?
- General and specific objectives
- Team composition, resources and sequence of events
- People met with

4 - Results

- Laboratory confirmation: type of specimens, number and results
- Epidemiological description (time, place and person):
 - date of the alert and the first cases,
 - number of cases and deaths, case fatality rate,
 - epidemic curve,
 - attack rate by location,
 - attack rate by age group.

Describe the situation, from the general to the specific (e.g., regions and districts, IDP camps and sectors, city and neighbourhoods). Specify the data source.

5 - Analysis of results and discussion

- Is the outbreak confirmed, and according to which definition?
- Is there laboratory confirmation?
- Which are the hardest hit places and populations?
- Which control measures have been implemented?
- What are the current response capabilities? Are they appropriate and sufficient?
 - surveillance and laboratory,

- patient management (treatment protocol, availability of drugs and supplies, human resources, etc.),
- vaccination,
- information.
- Available resources: staff, laboratory, medical and non-medical supplies, etc.

6 - Conclusion(s)

7 - Recommendations/proposed interventions

- Surveillance and laboratory
- Patient management
- Vaccination
- Informing the population

Specify the protocols, target populations, strategies and means.

8 - Appendices

- Tables
- Graphs

To speed up or improve the response, technical support may be needed for:

- surveillance ;
- case management: organisation, supervision and procurement ;
- the vaccination campaign: logistics and medical support for planning, organisation, supervision and assessment;
- assessing the intervention: functioning, results, impact, cost ;
- emergency preparedness: technical support and training.

Evaluate the need for technical support as soon as the outbreak begins. Draw up the terms of reference or collaboration.

3.7 The investigation in practice

3.7.1 What to do during the investigation?

- Collect information on all suspected cases.
- Verify the effectiveness of the surveillance and strengthen it, if necessary.
- Collect laboratory samples to confirm the causative agent.
- Make sure that patients are being managed effectively.
- Decide whether outbreak response vaccination is needed.

During the investigation, also collect information on the current response and available resources, and assess the response capacity in the field:

- appropriate patient management ;
- availability of drugs (name and quantity) ;
- access to treatment: geographic coverage, cost per patient, sufficient number of staff ;
- estimated vaccination coverage in recent years ;
- cold chain capacity ;
- previous outbreak response vaccinations and lessons learned.

3.7.2 Composition of the investigation team

The team should include an epidemiologist (or experienced person), a lab technician (or experienced person), and a logistic officer. Each person's role should be clearly defined, to ensure that all activities are covered without any duplication.

Recruit a driver who knows the region and, if possible, the local language.

3.7.3 Preparing for the investigation

Rigorous preparation makes the teams' work in the field easier. This includes:

- studying the responses to previous outbreaks (reports, surveillance data) and anticipated responses to future outbreaks (annual response strategy);
- identifying the locations to be investigated, according to the alert from the surveillance system or information reported by the population;
- obtaining pre-authorization from the relevant central authorities;
- organising the logistical resources;
- preparing the supplies and the information and data collection forms;
- preparing the supplies for collecting and transporting samples;
- preparing "simple case" and "complicated case" treatment kits, to be distributed, if necessary, to the health posts and hospitals visited;
- informing the local authorities;
- drawing up the budget and make it available.

3.7.4 Supplies and documents

Logistics and communications

- A terrain-appropriate vehicle in good working order
- Maps of the region
- Functional, appropriate means of communication

A camera and a GPS may be useful.

Laboratory

- Specimen collection and shipment supplies (e.g., syringes, needles, tubes, gloves, compresses, adhesive tape, filter paper, triple packaging bags)
- Information cards for samples
- Cold chain for samples, if necessary (vaccine carrier, ice packs and thermometer)

Data collection

- Population census
- List of health care facilities, personnel (health system) and contacts
- Inventory sheets for drugs, medical supplies and the cold chain
- Reference documents (case definition, data collection sheets)
- Paper, pens, calculator

Medical supplies

- Treatment protocols
- Treatment kits
- First aid kit

3.8 Key points

- The investigation requires rigorous preparation.
- The effectiveness of the response depends primarily on how quickly the outbreak is identified.
- The case definition should be simple, clear, standardised and constant throughout the entire period.
- Laboratory confirmation should be done on the first 5 to 10 cases, at a minimum.
- Demographic data should be reliable and the choice, made by consensus, should be justified.
- Describe the epidemic in terms of Time - Place - Person: scale and evolution, geographic spread, groups at risk.
- The definition of an outbreak varies according to the context.
- For each area, assess the outbreak's severity and potential for spreading using the analysis table.
- Assess the initial actions taken to manage the outbreak.
- Write an accurate, concise investigation report and distribute it.

Chapter 4: Outbreak management

[4.1 Outbreak management committee](#)

[4.2 Epidemiological surveillance](#)

[4.3 Patient management - Principles and organisation](#)

[4.4 Choosing the outbreak response vaccination strategy](#)

[4.5 Information and social mobilisation](#)

[4.6 Key points](#)

4.1 Outbreak management committee

An outbreak management committee must be formed at the national, regional and district levels. This committee is charged with “managing” the outbreak, that is, ensuring that resources are appropriate to needs.

The committee meets on a regular basis: daily at the start of the outbreak, and then weekly until the operation is over. The meetings are short and have clear agendas.

The minutes are distributed to managers at the various levels and to the partners. Feedback can also be given via a weekly report relaying the essential information.

4.1.1 Composition of the committee

At each level, the committee is composed of representatives from:

- the Ministry of Health (including representatives from the national immunisation programme);
- the laboratories;
- the hospitals;
- the administrative authorities;
- the support agencies (WHO, UNICEF, bilateral cooperation) and non-governmental agencies involved.

Outbreak response requires close coordination with other sectors, which participate in the committees according to the needs. These sectors are:

- information (radio, newspapers and television): the media disseminates information on the existence of an outbreak, the symptoms of the disease, treatment locations, free care, and vaccination dates/locations;
- education: schools can host vaccination sites; teachers can help make up vaccination cards and keep a tally of those vaccinated ;
- customs: it can facilitate the importation of drugs, medical supplies and vaccines ;
- public safety: the police can help maintain order during mass vaccination campaigns.

4.1.2 The committee's role

The Terms of Reference (responsibilities and decision-making level) are drawn up on a case-by-case basis.

The major strategic directions are generally decided at the national level. The other levels (regional and district) are involved in the warning system and in implementing the response. Subcommittees can be charged with specific technical aspects such as laboratory, vaccination, information and communication, logistics, etc.

Defining strategies

The committee defines the surveillance, patient management, vaccination and public information strategies ([Table 4.1](#)). It implements activities by mobilising the necessary resources and coordinating and informing the partners.

Table 4.1: Objectives and key steps in defining strategies

	Objectives	Key steps
Epidemiological surveillance	<ul style="list-style-type: none"> To provide weekly data for decision-making. To define priorities. 	<ul style="list-style-type: none"> Reach a consensus on a standard case definition. Strengthen or establish a simple, regular and reliable data collection system. Define patient management and vaccination priorities. Get feedback from staff and partners.
Patient management	<ul style="list-style-type: none"> To shorten the time between the first signs of the disease and treatment. To reduce the CFR and sequelae. To make treatment available at all times and at all levels. 	<ul style="list-style-type: none"> Create and distribute treatment protocols (hospital and peripheral centres). Assess needs in terms of: <ul style="list-style-type: none"> specific treatments; inpatient capacity (beds, staff and means); nutrition care. Define the drug supply strategy: <ul style="list-style-type: none"> determine the composition of the kits; centralise kit preparation; organise the distribution (timetable and priorities). Set up a monitoring system for quantities distributed and drug availability.
Vaccination	<ul style="list-style-type: none"> To quickly protect the at-risk population. To limit the spread of the outbreak. 	<p>Decide whether or not to conduct a mass vaccination campaign. If yes, define:</p> <ul style="list-style-type: none"> WHO: define the target population; WHERE: identify the places to be vaccinated and prioritize them; HOW: approach and planning; WHEN: revise the vaccination schedule as a function of the weekly epidemiological data.
Public information	<ul style="list-style-type: none"> To provide the public clear, practical information on the outbreak, patient care and vaccination. 	<p>Determine:</p> <ul style="list-style-type: none"> WHICH messages; TO WHOM they are addressed; HOW to transmit them.

Arranging for free care

The committee decides what will be free of charge to the public and identifies who will pay the costs for the different components of patient care:

- outpatient visits;
- hospitalisation;
- medications provided specifically for measles and its complications;
- other treatments (e.g., for malaria);
- laboratory tests done as part of measles surveillance;
- transfer of severe cases.

Estimating the budget

The committee draws up budget forecasts, taking into account the following costs:

- personnel: salary, per diem and training;
- drugs and medical supplies;
- vaccination: vaccines, cold chain, injection supplies, kits and modules;
- international and domestic shipping;
- staff transportation: vehicle rentals, fuel, travel, etc.;
- logistics equipment: ropes, stakes, tents, megaphones, etc.;
- administrative supplies: vaccination cards, date stamps, tally sheets, training documents, etc.;
- information and social mobilisation;
- communications equipment (telephone and card, radio, etc.).

The cost of vaccinating one person in a mass vaccination campaign will vary depending on the context and the means deployed. In 2011, it was estimated to be between €1.4 and €2 per person vaccinated.

Evaluating the response

Evaluation is an essential component of any operation. It should be planned and prepared before the response begins. The aim is to improve operations by formulating recommendations with regard to what was done in practice.

As soon as the operation begins:

- Define the objectives.
- Define the evaluation indicators.
- List the information that will be needed.
- Set up data collection (e.g., stock cards, donation forms, patient registers, epidemiological forms, etc.).
- Define the methodology.
- Identify and train the people who will be in charge.
- Train and supervise the evaluators.

4.2 Epidemiological surveillance

Once an outbreak has been confirmed, epidemiological surveillance must be stepped up. The goals of the surveillance system are:

- to identify new epidemic foci early;
- to monitor the evolution of the outbreak;
- to arrange for appropriate patient care;
- to evaluate response activities.

4.2.1 Case registration

The registers ([Appendix 5](#)) are the foundation of all data collection. The decision is whether to set up special registers for measles cases or to use the existing registers. Whichever approach is chosen, registers must be available in every facility, and must remain there.

The following information should be collected for each measles case: admission date, name, address, sex, age, diagnosis, treatment, treatment outcome, and immunisation status.

4.2.2 Description of the epidemiological surveillance system

Data

Basic information

At the end of every epidemiological week, all health care facilities send their weekly measles data up to the next higher level. In order not to weigh down surveillance, only the basic information (number of new cases and deaths) are transmitted on a weekly basis.

Supplementary information

Immunisation status of cases, and age group: these data must be entered at health centres and hospitals, but are not routinely transmitted to the next level. They will be used only if more detailed analysis is needed.

Zero reporting

If there were no cases seen over the course of the week, that information should be transmitted. This is known as "zero reporting". Failing to report is equivalent to missing data, and does not mean there were no cases.

Data transmission

Use the fastest means of communication available to transmit data (telephone, SMS, MMS, email, radio, etc.).

Every week, the person in charge transmits the number of cases and deaths, either by the standard, pre-established forms or by telephone. If transmitting the data verbally, one paper copy of the report is routinely sent to the next higher level and the other is kept in the facility.

Every visit to a health care facility in an affected region (supervision of treatment activities, supply or vaccination) is an opportunity to collect, verify and transmit data.

Data compilation

Data are usually compiled and analysed at the district level (incidence rate, attack rate and case fatality rate) and then transmitted to the regional level. After compilation and analysis at the regional level, the data are transmitted to the national level.

At each level, the person responsible for surveillance checks the data for completeness and promptness in transmitting them. He enters them, verifies that they tally with the transmitted forms, and links them to the laboratory data, if applicable.

Data analysis

The analysis (Time - Place - Person) is done at every level, every week, as soon as the epidemic season begins. This is a crucial step for identifying and management outbreaks.

Displaying the data in the form of tables, graphs ([Appendix 6](#)) and maps facilitates the analysis. While the software tool makes it easier to organise the data, it is not absolutely necessary at all levels. At the clinic level, for example, a simple graph posted on the wall and updated each week will show any uptick in the number of cases and allow case fatality rate monitoring.

Laboratory surveillance

After the first few samples (confirmation and genotyping), it is not necessary to monitor continually throughout the outbreak. For laboratory surveillance, consult the country's national recommendations.

4.3 Patient management - Principles and organisation

4.3.1 Decentralised care

Early treatment of cases is a priority in order to reduce the case fatality rate, complications, and sequelae of measles. Decentralised curative care is the only way to shorten the time between the onset of symptoms and the start of treatment. The chosen strategy should ensure that appropriate treatment is available at all levels.

Treatment centres are distributed so that they cover the entire area affected by the outbreak. In some cases (where hospital referral is difficult or impossible), it may be necessary to open temporary inpatient units (in a public building, tents, etc.) for the duration of the outbreak.

4.3.2 Referral system for severe cases

There must be an efficient referral system in place for transferring complicated cases to inpatient departments.

Everyone should be familiar with the transfer criteria and treatment protocol prior to transfer. Transfer forms should be available in all peripheral centres, and the transfer should be noted in the measles case register.

4.3.3 Free care

To guarantee access to care, treatment, patient transfer and hospitalisation absolutely must be free of charge.

4.3.4 Patient isolation

As soon as the first cases are identified, area health care facilities should take transmission prevention and patient isolation measures.

Clinics and health centres (outpatient treatment)

Advise parents to avoid gathering places (e.g., schools, cultural or sporting events, etc.).

There is significant measles transmission in health care facilities waiting rooms, where a lot of people are gathered in often small, poorly-ventilated areas.

It is therefore necessary to:

- identify patients with measles symptoms (fever and rash) as soon as they arrive, and send them to a special waiting room/area to protect uninfected patients ;

- air out waiting rooms frequently and fully to replace the air contaminated by microdroplets expelled by infected patients.

Hospitals and temporary measles inpatient units

- Keep cases together and isolated throughout their hospital stay.
- Provide health care staff and all the necessary medical supplies for managing the cases.

The functioning of the measles unit is established before it opens ([Appendix 8](#)).

4.3.5 Care staff training and supervision

Caregiver training and supervision are essential.

Training

Assess knowledge and if necessary hold training and refresher sessions:

- basic training by personnel level, during which training documents, protocols and treatment kits are distributed ;
- continuing education during supervision visits.

Supervision

Supervision visits are an opportunity to supply the centres, to reinforce epidemiological surveillance and to discuss complex clinical cases and any difficulties encountered.

An initial visit to all health care facilities in the affected area is indispensable as soon as supply is set up.

It allows the supervisor to:

- provide the staff with clear, accurate information (case definition, data collection, protocol, free care, referral criteria, and answers to medical questions) and verify that it is understood;
- define a supply strategy with the staff;
- inform the authorities and the public.

Other visits are then scheduled to answer practical questions, monitor inventory management and record keeping, and assess the quality of care.

4.3.6 Supplying treatment facilities

Estimating the number of treatments needed

Drug and medical supply needs are estimated based on the expected number of cases, the number of facilities to be provisioned, and the existing stocks ([Appendix 9](#)). Allow for a reserve supply.

The expected number of cases is estimated based on the average cumulative attack rate seen in previous outbreaks or on observations of other outbreaks. A study of seven outbreaks between 2002 and 2008^a shows a cumulative attack rate for the duration of the outbreak somewhere between 300 and 1,400 cases per 100,000 (or between 0.3 and 1.4%). An initial estimate based on an attack rate of 500 to 750 cases per 100,000 seems reasonable.

Example: Matadi (DRC), population 300,000

At-risk population	300,000
Estimated number of cases (attack rate 500/100,000)	1,500
Subtract the number of reported cases to date	– 400
Estimated number of new cases through the end of the outbreak	1,100
Add a 25% reserve	275
TOTAL treatments needed	1,375

The proportion of patients requiring hospitalisation will vary between 10 and 20% of cases, depending on the context (access to care, etc.).

In this example, it is assumed that 15% of patients will require hospitalisation, and so the number of “complicated case” treatments needed is: $1,375 \times 0.15 = 206$.

The initial estimate at the start of the outbreak permits an order for the first few weeks. Depending on the course of the outbreak, vaccination activities and inventories, further orders may be needed.

A standard treatment protocol permits ordering based on the list of selected items and drugs.

Treatment kits

All outpatient and inpatient treatment facilities, at both the national and local level, are supplied in the form kits for the duration of the outbreak.

This simplifies the transport and management of stocks, reduces the risk of shortages and ensures patient access to the full treatment.

There are two types of kits ([Appendix 10](#)):

- the 10-treatment “uncomplicated case” kit for clinics and health centres;
- the 20-treatment “complicated case” kit for hospitals and temporary inpatient units.

To save time and allow a focus on other activities (e.g. support and exchanges with staff) during visits, the kits are prepared in advance at the central storehouse and then distributed to health care facilities. If necessary, one of the team’s medical staff can hire and train day workers to prepare the kits.

Supply planning

This is defined according to:

- the epidemiological data (number of cases, shape of the epidemic curve, and case fatality rate);
- the accessibility of treatment facilities: distance, travel time, road conditions, and security;
- staff supervision needs;
- the available resources: vehicles, public/private transportation, and fuel;
- the availability of qualified personnel to supply the facilities and supervise patient treatment.

There are several possible options:

- Mobile teams supervise and supply care facilities and collect data.
- Health staff collect supplies directly from the central pharmacy and bring their weekly data.
- A combination of the two.

Using rapid means of communication (telephone and radio) enables contact for fine-tuning support and supply.

Kit distribution strategy

The goal here is to ensure that each facility has treatments available at all times throughout the outbreak ([Appendix 11](#)).

1) Initial coverage of the zone

As soon as an outbreak is confirmed, kits are sent as quickly as possible to all health care facilities in the area in question. They are distributed, in the following order of priority, to:

- hospitals and temporary measles inpatient units;
- the health care facilities reporting the largest number of cases, and particularly those with the highest case fatality rate;
- all health centres that report cases;
- health care facilities that have not yet reported any cases: pre-position a 10-treatment "uncomplicated case" kit.

Standardized case definitions, admission criteria, treatment protocols ([Appendix 13](#)) and weekly epidemiological data collection forms are distributed at the same time to all the facilities being supplied.

2) Subsequent supply

Supply then continues to all facilities according to the number of reported cases, the theoretical number of treatments in stock, and the case fatality rate. The period for which treatments will be given is defined as a function of the workload and the logistical resources available ([Appendix 11](#)).

Note:

- Do not give all of the treatment kits at once, but rather for a specific period.
- Avoid dispersal: treatments may be allocated unnecessarily to centres that are not treating cases, to the detriment of centres that are treating a lot of cases and on which resources should be concentrated.
- When the outbreak is over, continue to distribute treatment kits for a few weeks following the vaccination campaign to ensure treatment of the last few cases.

Footnotes

(a) MSF internal reports

4.4 Choosing the outbreak response vaccination strategy

Outbreak response vaccination is defined based on several factors: identification of at-risk priority zones, a target population and coverage objectives.

Whatever the response, stepped-up surveillance and patient care are always the top priority.

Though there is often a lot of debate and pressure over the choice of zones to vaccinate and the strategy (mass vaccination and/or stepped-up routine vaccination), decisions need to be made quickly. The choice takes into account the available human, logistical and financial resources that can be mobilised effectively^[1].

The most appropriate approach is determined based on analysis of the potential for spread.

Table 4.2: Response according to the potential for spread of the outbreak

Potential for spread	Level of response	Situation	Outbreak response vaccination
Low	Vigilance	No confirmed outbreak	<p>Rapidly step-up routine vaccination.</p> <p>Identify groups or areas in which coverage is low and focus efforts there. Discuss extending vaccination up to age 5 years.</p> <p>Catch-up for unvaccinated children.</p>
High	Alert	Outbreak confirmed or not	<p>Rapidly implement selective or non-selective vaccination up to age 5 years: vaccination campaign or stepped-up routine vaccination in health care facilities and by mobile teams.</p> <p>Extending vaccination beyond age 5 years is discussed based on an analysis of the data collected (attack rate, number of cases and vaccination coverage) and the resources available.</p> <p>Reduce the risk of spread.</p>
Very high	Rapid response	Outbreak confirmed according to a preestablished definition	<p>Begin a non-selective mass vaccination campaign as soon as possible.</p> <p>Discuss the age groups to be vaccinated based upon an analysis of the data collected (attack rate, number of cases and vaccination coverage) and the resources available.</p> <p>Vaccination in the epidemic focus is recommended.</p> <p>Even if the outbreak is identified belatedly, it is not too late to act.</p> <p>Control the outbreak.</p>

4.4.1 Stepping up routine vaccination activities

As soon as an outbreak is suspected, make sure that routine vaccination activities are operating correctly and are effective.

In the absence of vaccination coverage survey data, an analysis of routine vaccination data helps identify pockets of low coverage. Identifying the reasons for non-vaccination in these zones permits an understanding of the perception of and barriers to vaccination and the implementation of appropriate response strategies.

Informing and mobilising the public

Awareness-raising messages must consider the population's perception of vaccination (acceptability/resistance) and its knowledge (population accustomed or not to routine vaccination). Consider previous experiences. All effective channels of communication should be used.

Improving access

- Routinely check immunisation status in all activities (curative and preventive), including accompanying children.
- Hold daily vaccination sessions with extended hours.
- Increase the frequency of mobile team rounds or step-up other forward operating strategies.

Increasing resources

- Ensure the availability of vaccines and injection supplies.
- Offer logistical support (cold chain, transportation, fuel).
- Provide ad hoc human resource reinforcement (additional staff assigned to vaccination during the period).

4.4.2 Mass vaccination campaign

The objective of the campaign is to limit the number of cases and deaths and to contain the outbreak by vaccinating at least 90% of the target population.

Whenever possible, begin with densely populated zones (urban areas and refugee/IDP camps), because that allows rapid protection in the zones at highest risk and where accessibility, logistics and supervision are easier.

The proposed vaccination hours should take the population's activities and work schedule into account.

Urban and densely-populated areas

In urban areas, it is better not to involve the health care facilities in the vaccination campaign. The work overload could compromise patient care. Special, temporary vaccination sites should be set up. To be accessible to everyone, the vaccination sites should be distributed among the various neighbourhoods according to the size of their populations.

At the end of the campaign, maintain vaccination sites in the health care facilities for at least one week to vaccinate latecomers.

Other approaches are combined with setting up vaccination sites:

- Mobile vaccination teams:
 - in school settings: primary and secondary or high schools where many children go to school. The smaller schools should bring their children to the vaccination sites at the larger schools during the least busy times, or by appointment, for example;

- in other group settings: day care centres, nursery schools, orphanages, juvenile detention centres, etc.;
- for populations living far from health centres or in remote areas (e.g., nomads);
- for groups that do not like to mix with other groups (e.g., castes).
- Other approaches: consider any alternative approach that allows vaccination of groups identified as having low vaccination coverage (e.g., door-to-door).

Rural areas

In rural areas, the response is a combination of several vaccination strategies:

- ad hoc reinforcement of vaccination capacity for existing care facilities: contribution of human, technical or logistical resources;
- sending mobile teams into areas that are far away from health centres. This is the most appropriate option for reaching populations without access to care (nomads or dispersed groups).

These mobile teams are smaller than those in urban areas. The teams can stay one or more days in selected locations, serving several localities, if possible. Failing that, they can travel among the localities to be vaccinated using a predefined circuit, provided the population has been informed ahead of time.

Achieving effective vaccination coverage rates requires significant logistical resources and a longer campaign than in urban areas. Supervision is also much more complex.

4.4.3 Identifying the target population

Calculating location- and age-specific attack rates allows identification of the geographic areas and age groups to be targeted first.

Priority areas

- Particularly high-risk areas: paediatric inpatient units, feeding centres, facilities for young children (child care centres, schools, orphanages, etc.)
- Densely-populated areas (cities, slums, refugee camps, displaced population)
- Areas with the highest attack rates, taking into account the shape of the epidemic curve
- Areas with low vaccination coverage

At-risk groups

The choice of the target population depends on the attack rate and the absolute number of cases in each age group^[2], on the objectives (reducing the morbidity and mortality), and on the amount of resources to be mobilised.

Be careful when interpreting the attack rate; for example, though the attack rate for 5- to 15-year-olds may be lower than that for children under 5, it may actually correspond to more cases, because 5- to 15-year-olds represent a larger percentage of the total population.

4.4.4 Evaluating the constraints

When planning a vaccination campaign, take the following constraints into account:

- the supply time for vaccines and supplies;
- logistical capacity: when limited, it is better to start the campaign quickly, targeting the priority zones, than wait for the means for a larger scale operation that will be too late. This allows time to mobilise the means for vaccinating in other zones;
- available personnel;
- accessibility: road network, distance, population density;
- special events (holidays, elections, food distribution, etc.);
- security.

Emergency vaccination campaign preparation should not take more than two weeks.

4.4.5 Other points to be determined

Selective or non-selective vaccination

- Selective vaccination: routine check of the child's vaccination status based on the vaccination card. If vaccination is proven (the card is shown), the vaccine is not administered.
- Non-selective vaccination: all children are vaccinated, no matter what their vaccination history (cards not checked).

Non-selective vaccination, which is faster, is the preferred option in outbreak response vaccination campaigns. The choice should be made as soon as planning begins, as it will have an impact on the resources to be deployed and activity organisation.

Vitamin A distribution

Preventive doses of vitamin A (oral **retinol**) are distributed at all measles mass vaccination campaigns (except in cases of recent administration, i.e., within the past month).

Inquire about previous or planned vitamin A distributions.

- Children 6 to 11 months: 100,000 IU single dose (4 drops from a 200,000 IU capsule)
- Children 1 to 5 years: 200,000 IU single dose (one capsule)

Other activities

- Other vaccinations:

While it is possible to add other vaccines, it must be justified. This might be considered when there is another epidemic occurring at the same time (e.g., meningitis, yellow fever, polio) or in certain special situations (e.g., refugee camps, population displacements, or remote areas with very low polio, pneumococcus, *Haemophilus influenzae* (Hib) or yellow fever vaccination coverage).

- Other activities:

Other activities may be conducted during vaccination campaigns, such as deworming, or distribution of insecticide-treated mosquito nets or nutritional supplements.

The organisation of the vaccination flow will have to be adapted, the duration of the campaign extended, and the personnel given specific training. Always weigh the potential benefits of additional activities against the implementation constraints (including the delay in achieving effective vaccination coverage) they entail.

References

1. World Health Organization. *Response to measles outbreaks in measles mortality reduction settings*. CH-1211 Geneva 27, Switzerland. WHO/IVB/09.03
http://apps.who.int/iris/bitstream/handle/10665/70047/WHO_IVB_09.03_eng.pdf?sequence=1
2. Ferrari M. J., Djibo A., Grais R. F., Grenfell B. T., Bjørnstad O. N. *Episodic outbreaks bias estimates of age-specific force of infection: a corrected method using measles as an example*. *Epidemiology and Infection* / Volume 138 / Issue 01 / January 2010, pp 108-116

4.5 Information and social mobilisation

Outbreaks often cause panic among the affected population. Information and sensitization activities are therefore essential. Information is disseminated as soon as the outbreak is confirmed.

4.5.1 Coordination

Communication is coordinated by a technical committee composed of administrative and health officials, leaders, and partners. The committee's job is to identify sensitization activity needs, draw up the budget and ensure implementation as quickly as possible.

Vaccination campaigns require involvement from all sectors. Messages are transmitted in a variety of settings (health centres/hospitals, schools, public places, places of worship, etc.).

The team responsible for sensitization activities is composed of one person who is in charge and several mobilisers. The person in charge acts as the liaison between the mobilisers and the technical committee.

4.5.2 Messages

Messages should contain only the essential points ([Appendix 12](#)):

- what: treatment for measles patients and measles vaccination;
- why: outbreak;
- when: dates;
- where: vaccination locations.

It may be necessary to adapt the messages in case there are rumours (e.g., that the vaccine poisons children) or to raise the awareness of a group that is opposed to vaccination.

4.5.3 Media

Depending on the context (urban or rural), cultural habits and available resources, town criers, griots, local personalities, religious or association leaders, radio, TV and text messaging may be used.

4.5.4 The mobilisers' role

The mobilisers' job is to disseminate information to the public.

- A few days before the campaign, they:
 - identify and contact influential people to inform them;
 - visit the neighbourhoods/communes and organise discussions to raise the public's awareness of the importance of vaccination;
 - disseminate the messages as widely as possible (megaphone, radio or other).
- During the campaign, they:

- continue sensitization activities, especially in areas of low vaccination coverage;
 - go up and down neighbourhoods encouraging families to take their children to the nearest sites;
 - answer any questions;
 - report on their activities and any difficulties encountered.
- After the campaign, they report on the strengths and weaknesses and any difficulties encountered.

4.6 Key points

- As soon as the alert is sounded, an outbreak management committee responsible for organising the response is created or reactivated at each level.
- The role of the committee is to define the strategies, organise free care, coordinate the partners, monitor implementation, draw up the projected budget and prepare the evaluation of the response.
- A reliable data entry and transmission system is essential to detecting the outbreak, monitoring its course and orienting the response.
- Epidemiological data analysis is done each week at all levels.
- Patient care is decentralised to shorten the time between the onset of symptoms and the start of treatment.
- Treatment is free of charge.
- Patients are isolated.
- The distribution of treatments kit facilitates supply.
- Treatments should be available at all health care facilities throughout the outbreak. Regular monitoring of treatment availability allows supply planning.
- Analysing the specific attack rates by age group and location helps determine which areas to vaccinate first and the age of the target population.
- The choice of outbreak response vaccination strategy is guided by the risk of spread of the epidemic.
- Emergency vaccination campaign preparation should take no more than two weeks.
- Information and social mobilisation are implemented as soon as the outbreak is confirmed.
- A broad range of media should be used to transmit messages.

Chapter 5: Case management

[5.1 Clinical aspects](#)

[5.2 Patient triage](#)

[5.3 Treatment of uncomplicated cases](#)

[5.4 Treatment of complicated cases](#)

[5.5 Key points](#)

5.1 Clinical aspects

5.1.1 Incubation

The average incubation period is 10 days (8 to 13 days) from the date of exposure to the virus to the onset of the first clinical signs.

5.1.2 Clinical presentation

Prodromal phase

This phase lasts 2 to 4 days.

- fever with temperature over 38 °C, often over 39 °C;
- cold-like symptoms: non productive cough and/or coryza (runny nose) and/or conjunctivitis (red eyes with discharge);
- Koplik's spots: tiny bluish-white spots (2 to 3 mm) on an erythematous base, found on the inside of the cheeks. They appear 1 to 2 days before the rash, and last 2 to 3 days. This sign is specific of measles infection, but hard to identify. Observation of Koplik's spots is not required for diagnosing measles.

Measles rash

Begins an average of 14 days after exposure, and lasts 4 to 6 days.

- erythematous, nonpruritic maculopapules that blanch under pressure; they may coalesce
- into patches separated by healthy skin;
- the rash starts at the forehead and spreads progressively downward to the face, neck, chest, abdomen, and lower extremities over 3 to 4 days.

At the same time, the cold-like symptoms improve. If there are no complications, the fever disappears once the rash reaches the feet. The rash then gradually disappears and the skin desquamates.

Recovery phase

Pigmented skin takes on a tigroid appearance, and then desquamates intensely for 1 to 2 weeks.

5.1.3 Differential diagnosis

Rubella (accompanied by posterior cervical lymphadenopathy), erythema infectiosum, roseola infantum (transient rash involving mainly the trunk), infectious mononucleosis, scarlet fever, epidemic typhus, certain rickettsial infections, medication-related erythema, etc.

5.1.4 Acute complications

Measles can have a number of complications^{a[1]}. 75% of measles cases experience at least one complication. Most deaths are due to complications.

Respiratory and ENT complications (viral or bacterial)

In children under 5 years, these are the most common complications, both during and after the disease. In adults, pulmonary complications are less common, but more severe than in children.

- **Acute otitis media**

5 to 15% of measles cases are complicated by acute otitis media.

- **Pneumonia**

5 to 10% of patients have pneumonia.

- **Acute laryngotracheobronchitis (croup)**

Croup is a potential complication in children. Most children have moderate, self-limited disease lasting 2 to 5 days. Children should be monitored during this period, however, because their general and respiratory status can deteriorate rapidly.

Symptoms of croup include a characteristic "barking" cough, hoarse crying or voice, difficulty breathing, and a high-pitched inspiratory wheeze (inspiratory stridor) caused by inflammation and narrowing of the larynx.

Croup is considered benign or "moderate" if the stridor occurs when the child is agitated or crying, but disappears when the child is calm.

Croup is severe when the stridor persists at rest or is associated with signs of respiratory distress.

Ocular complications^[2]

Eyes are usually red with a watery discharge. These symptoms are typical and benign, and are not considered a complication.

The most common ocular complications are bacterial infections and xerophthalmia due to vitamin A deficiency^b.

Diseases that cause corneal lesions (keratoconjunctivitis, keratitis, and xerophthalmia) may compromise the eye integrity and can progress to irreversible blindness.

- **Purulent conjunctivitis**

Purulent conjunctivitis is the most common – and most benign – complication.

- **Infectious keratitis and keratoconjunctivitis**

These infections are less common. They cause the cornea to lose its transparency or shininess.

When a fluorescein test can be done to confirm the diagnosis, the exam shows a single corneal erosion or ulcer^c.

- **Xerophthalmia**

Xerophthalmia can be detected in any the following stages: Bitot's spots, corneal xerosis (dry, dull cornea), keratomalacia (opaque, softened, or perforated cornea).

Gastrointestinal complications

- **Diarrhoea**
Diarrhoea is a common complication during and after the disease. It can rapidly lead to dehydration, especially in children.
- **Oral lesions (stomatitis)**
Stomatitis is usually due to *Candida albicans*. Herpetic gingivostomatitis may occur.

Neurological complications

- **Seizures**
Seizures are the most common neurological complication.
- **Acute measles encephalitis**
This is a rare complication, occurring in 1 out of every 1000 to 2000 cases, about 3 to 6 days after the rash first appears. Symptoms include: recurrence or persistence of the fever, meningeal symptoms, impaired consciousness and seizures.

5.1.5 Other complications

Immediate

Thrombocytopenic purpura may develop 3 to 15 days after the rash appears.

Post-measles

- Measles can lead to malnutrition in the weeks following infection.
- Children are at high risk of death for several months, due to the temporary immune deficit that accompanies measles (increased risk of diarrhoea and respiratory infection).
- Noma (gangrenous gingivostomatitis) is a rare but extremely severe, non specific complication of measles. It affects malnourished children under age 4 years. It begins with severe, foul-smelling oral ulcers.

Delayed

Subacute sclerosing panencephalitis is a very rare complication (1/100,000 cases) that occurs long after the initial infection (an average of 7 years).

5.1.6 Co-morbidities

Acute malnutrition

Malnourished children are at risk for developing severe complications.

HIV infection

Measles tends to be severe and prolonged in immunodepressed people. The skin rash may be absent. There are two particularly fearsome complications: giant cell interstitial pneumonia and measles inclusion-body encephalitis. The main cause of death in children is the pneumonia, and in adults, the encephalitis.

Footnotes

- (a) Complications are related to epithelial changes (pulmonary and gastrointestinal) and to temporary, measles-related immune suppression.
- (b) In addition to ocular lesions, vitamin A deficiency weakens the immune system.
- (c) The normal cornea does not stain with fluorescein; if there is epithelial loss, fluorescein stains the lesion green.

References

1. Perry RT, Halsey NA. *The clinical significance of measles: a review*. J Infect Dis. 2004 May 1;189 Suppl 1:S4-16
2. World Health Organization. *The child, measles and the eye*. CH-1211 Geneva 27, Switzerland. WHO/EPI/TRAM/93.05 (updated 2004).
http://www.who.int/immunization/programmes_systems/interventions/ChildMeaslesEyeENG300.pdf

5.2 Patient triage

5.2.1 Diagnosis and sorting

Look for clinical signs of measles, and determine whether the patient is a “complicated case” or an “uncomplicated case”.

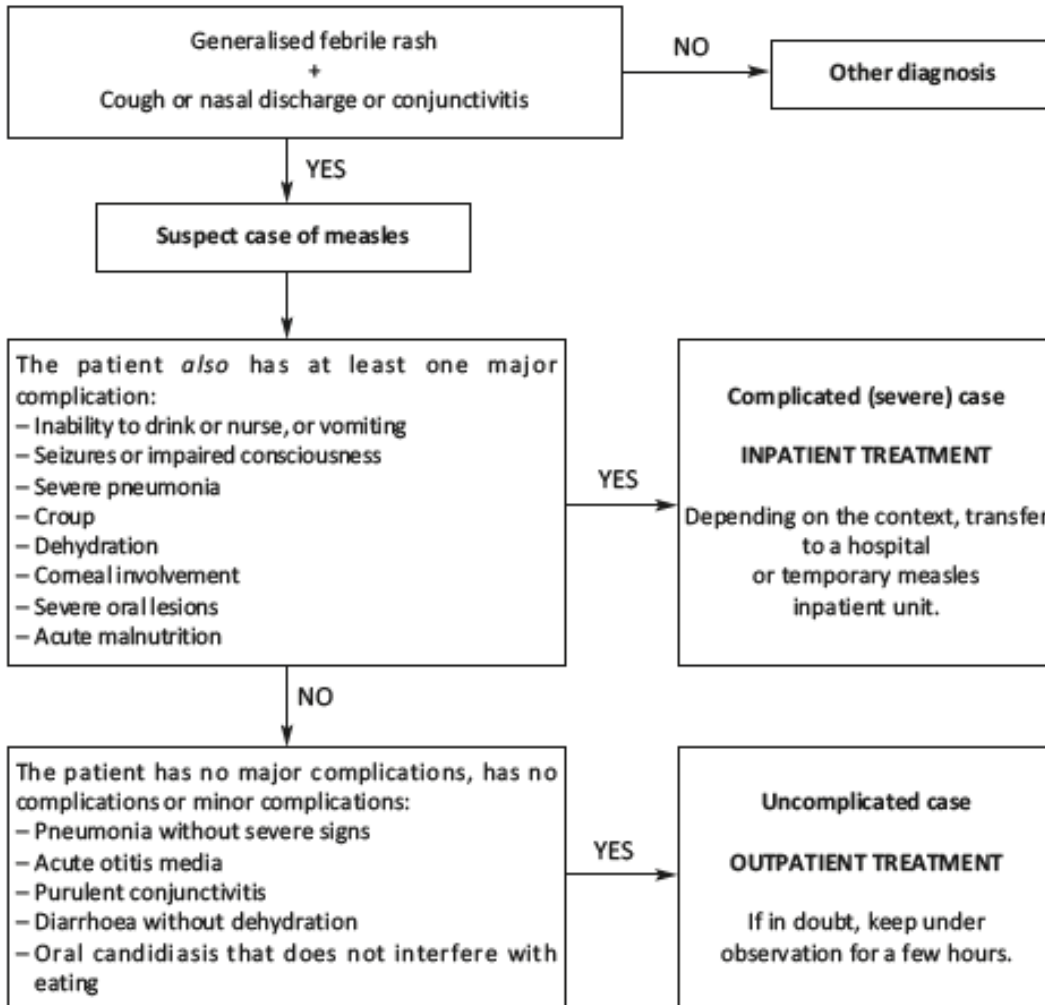

5.2.2 Initial clinical examination

Confirm the measles diagnosis

The rash consists of non pruritic small red or pink spots (macules) that are separated by areas of healthy skin and blanch under pressure.

The patient also has a cough and/or runny nose and/or eye discharge.

Measure the axillary temperature or, at a minimum, verify that the child feels "hot". The fever is generally high (> 39 °C).

Look for respiratory complications

Check that the child is breathing normally, and is not congested or dyspnoeic.

In case of nasal obstruction (common), clear the nasopharynx.

If he is coughing or dyspnoeic, measure the respiratory rate (RR). Auscultate the patient, if possible, depending on the examiner's skills.

Using the following criteria, hospitalise children with severe pneumonia. Uncomplicated pneumonia with no severity criteria can be treated on an outpatient basis, if the child is not a "complicated case" for other reasons.

Pneumonia (no severe signs)	Severe pneumonia
<p>Fever and cough +</p> <p>Dyspnoea (high respiratory rate)^(a) RR ≥ 60 in a child under 2 months RR ≥ 50 in a child from 2 to 11 months RR ≥ 40 in a child from 1 to 5 years</p> <p>+</p> <p>Crackles on auscultation</p>	<p>Signs of pneumonia +</p> <p>At least one criterion for severity:</p> <ul style="list-style-type: none"> • Respiratory distress, one of more signs of laboured breathing such as chest indrawing, nasal flaring, grunting, or head nodding • Cyanosis or SpO₂ < 90% • Inability to drink • Children under 2 months • Severe malnutrition

(a) In children with severe malnutrition, reduce these thresholds by 5.

Hospitalise any children with stridor (mild to moderate or severe croup).

Look for otitis

Look for ear pain and purulent discharge from the auditory canal. Perform an otoscopic examination, if possible, depending on the examiner's skill.

Otitis can be treated on an outpatient basis, if the child is not a "complicated case" for other reasons.

Look for ocular complications

Clean the eye beforehand if copious secretions interfere with the examination. Examine each eye separately, using a flashlight. Examine the conjunctiva and cornea. Determine whether there is corneal involvement or not. Proceed with care as corneal lesions are often painful and accompanied by photophobia (the patient shields his eyes from the light).

The normal cornea is transparent (it allows a clear view of the iris and pupil), moist, and shiny (it reflects the light). Any abnormality: loss of transparency (opacity) or shininess (dull or dry cornea), or corneal softening (necrosis, perforation) is an indication for hospitalisation (= complicated case).

Purulent conjunctivitis by itself (purulent discharge with discomfort or foreign body sensation, without photophobia nor corneal involvement) can be treated on an outpatient basis, if the child is not a "complicated case" for other reasons.

The examination can show Bitot's spots, which are foamy, whitish patches on the bulbar conjunctiva (white of the eye). The child can be treated on an outpatient basis if he is not a "complicated case" for other reasons.

Look for oral lesions

Oral candidiasis (white patches on the tongue or within the oral cavity) is considered benign unless it prevents eating. It can be treated on an outpatient basis, if the child is not a "complicated case" for other reasons.

Painful or extensive lesions that prevent children from drinking or eating are all considered severe (= complicated case).

Look for dehydration and/or diarrhoea

In patients with diarrhoea, look for dehydration.

Look for dehydration in children even if there is no diarrhoea. They can be dehydrated for other reasons (e.g. insufficient fluid intake, repeated vomiting, or high fever).

No matter what the cause, patients who are dehydrated must be hospitalised (= complicated case).

Weight

Weight the child whenever possible.

Ability to drink

Put the child to the breast or offer him water to make sure that he drinks/eats.

Nutritional status

Look for malnutrition only if justified by the context (food insecurity or crisis, or displaced population) and in children under age 3 or 5 years.

First look for bilateral lower extremity oedema:

- if there is bilateral oedema: acute malnutrition (= complicated case);
- if there is no bilateral oedema, measure the mid-upper arm circumference (MUAC):
 - if MUAC > 125 mm: the child is not malnourished;
 - if MUAC ≤ 125 mm, weigh and measure the child to calculate the weight-for-height ratio (W/H).
If the W/H ratio is < -2 standard deviation: acute malnutrition (= complicated case);
 - if MUAC < 115 mm: severe acute malnutrition (= complicated case).

5.3 Treatment of uncomplicated cases

Standard treatment aimed at treating the fever and preventing the most common complications. Added to this standard treatment is the **treatment for minor complications** found on clinical examination ([Appendix 13](#)).

Standard treatment	<ul style="list-style-type: none">• Antipyretic: paracetamol PO• Antibiotherapy: amoxicillin PO for 5 days (children < 5 years)• Vitamin A: retinol PO on D1• Cleaning the eyes with clean water• Decongestion of the nasopharynx• Hydration; caloric feeding, divided meals (every 2 to 3 hours) or more frequent breastfeeding• Depending on the context, nutritional supplements for children < 3 or 5 years
---------------------------	--

AND

Treatment for minor complications	<ul style="list-style-type: none">• <i>Pneumonia with no severity criteria or acute otitis media:</i> amoxicillin PO for 5 days• Purulent conjunctivitis (no corneal lesions): Cleaning the eyes with clean water + tetracycline 1% eye ointment for 7 days• Bitot's spot (no corneal lesions): retinol PO: one dose on D1, D2 and D8• Uncomplicated watery diarrhoea (no dehydration): Oral rehydration solution (ORS) according to WHO Plan A (Appendix 14)• Minor oral candidiasis (does not interfere with eating): nystatin PO for 7 days^a
--	---

See [Appendix 13](#) for doses according to weight or age.

5.3.1 Treatment^b

Paracetamol is administered orally (oral solution or tablets, depending on age), in 3 to 4 divided doses over 24 hours for 2 to 3 days.

Five-day antibiotherapy (amoxicillin PO, except if resistance is known in the area) is given as a preventive measure to children under age 5 years. There are fewer complications (pneumonia and conjunctivitis) over the course of the illness, and better weight gain after the illness, in children on antibiotics. [1] Citation 1. May-Lill Gally, et al. *Prophylactic antibiotics to prevent pneumonia and other complications after measles: community based randomised double blind placebo controlled trial in Guinea-Bissau*. BMJ, doi:10.1136/bmj.38989.684178.AE (published 23 October 2006). <http://www.bmj.com/content/333/7581/1245.pdf%2Bhtml> . If a child under 5 years has non-severe pneumonia or acute otitis media, there is no change in therapy since the first-line treatment for these infections is the same as the standard antibiotic therapy already routinely administered.

Clearing the upper airways: blow the child's nose to prevent congestion and secondary respiratory infection and improve the child's comfort (especially during breastfeeding) and sleep. Nasal lavages with 0.9% sodium chloride solution may be useful in the event of significant nasal discharge ([Appendix 15](#)).

All patients receive a single dose of retinol (vitamin A)^c except:

- pregnant women (ask the patient);
- patients with Bitot's spots: these patients receive a curative 3-dose treatment.

When appropriate to the situation, children under 3 or 5 years receive ready-to-use food (500 kcal daily) for 2 weeks.

Start treatment during the consultation:

- administer the first dose of paracetamol, retinol, amoxicillin in children < 5 years;
- in the event of diarrhoea, start ORS; apply the first dose of tetracycline, nystatin, etc. depending on the complications identified.

Provide the necessary supplies (drugs, cotton, and supplements) to continue treatment at home.

5.3.2 Advice to parents

1) Ask parents to:

- make the child drink, and give smaller, more frequent meals or breastfeed more frequently;
- keep his eyes clean, blow his nose frequently.

2) Instruct parents on how to use the medications (including how to prepare the ORS, if applicable) and nutritional supplements. Make sure they understand the instructions.

3) Ask them to bring the child back in if his condition worsens; for example, if he cannot drink or nurse, or is vomiting, if his consciousness is impaired (he is difficult to awaken), he has respiratory problems, or the diarrhoea worsens.

4) Explain that after measles, complications can still occur and that they should bring the child back in right away if he does not recover completely.

If in doubt (e.g., with high fever or copious diarrhoea), keep the child under observation for 2 hours or more to assess the response to treatment (e.g., fever reduction) and make sure that he will be able to follow the treatment at home (e.g., that he can drink the ORS).

Footnotes

- (a) If nystatin is not available, gentian violet 0.25% may be applied 2 times daily for maximum of 5 days.
- (b) See also the guide: *Treating measles in children*. World Health Organization. WHO/EPI/TRAM/97.02 (updated 2004).
http://www.who.int/immunization_delivery/interventions/TreatingMeaslesENG300.pdf
- (c) The usual recommendation is to administer 2 doses of retinol (one on D1 and one on D2) to all measles patients. However in an epidemic context, the administration of only one dose on D1 to uncomplicated cases facilitates home care.

References

1. May-Lill Garly, et al. *Prophylactic antibiotics to prevent pneumonia and other complications after measles: community based randomised double blind placebo controlled trial in Guinea-Bissau*. BMJ, doi:10.1136/bmj.38989.684178.AE (published 23 October 2006).
<http://www.bmj.com/content/333/7581/1245.pdf%2Bhtml>

5.4 Treatment of complicated cases

Standard treatment aimed at treating the fever and preventing the most common complications. Added to this standard treatment is the treatment of complications found on clinical examination ([Appendix 13](#)).

Standard treatment	<ul style="list-style-type: none"> • Antipyretic: paracetamol PO (IV only if oral route impossible) • Antibiotherapy: amoxicillin PO for 5 days in children < 5 years, unless severe pneumonia (see below Treatment for pulmonary complications) • Vitamin A: retinol PO on D1 and D2, unless corneal involvement (see below Treatment for ocular complications) • Cleaning the eyes with clean water • Decongestion of the nasopharynx • Hydration, caloric feeding, divided meals (every 2 to 3 hours) or more frequent breastfeeding • Depending on the context, nutritional supplements in children < 3 or 5 years, unless acute malnutrition (see below Treatment of malnutrition)
---------------------------	--

AND

Treatment for pulmonary and ENT complications if any	<ul style="list-style-type: none"> • <i>Severe pneumonia:</i> ceftriaxone IV or IM + cloxacillin IV for 3 days then, if improvement, change to amoxicillin/clavulanic acid PO to complete 7 to 10 days of treatment + oxygen if cyanosis or SpO₂ < 90% + salbutamol if expiratory wheezing and sibilant rales on auscultation If suspect staphylococcal pneumonia: cloxacillin IV + gentamicin IM In all cases, close monitoring. • <i>Pneumonia with no severity criteria or acute otitis media:</i> amoxicillin PO for 5 days Use amoxicillin/clavulanic acid PO for 5 to 7 days only if amoxicillin alone fails (worsening or lack of improvement after 48 hours of properly-conducted treatment). • <i>Croup:</i> <ul style="list-style-type: none"> ▫ Inpatient monitoring (risk of worsening) and supportive therapy ▫ Severe croup: dexamethasone IM single dose + nebulised epinephrine (adrenaline) (Appendix 16) and intensive monitoring
---	--

AND

Treatment for ocular complications if any	<ul style="list-style-type: none"> • <i>Purulent conjunctivitis</i> (no corneal lesions): Cleaning the eyes with clean water + tetracycline 1% eye ointment for 7 days • <i>Corneal involvement</i> (corneal opacification or ulcer): Cleaning the eyes with clean water + tetracycline 1% eye ointment for 7 days + retinol PO one dose on D1, D2 and D8 + for ocular pain: eye protection and tramadol PO from age 12 years. No topical corticosteroids.
--	--

AND

Treatment for gastrointestinal complications if any	<ul style="list-style-type: none"> • <i>Watery diarrhoea</i>: <ul style="list-style-type: none"> ▫ Without dehydration: oral rehydration according to WHO Plan A ▫ With dehydration: rehydration according to WHO Plan B or C + zinc sulfate^(a) PO for 10 days (Appendix 14) • <i>Oral candidiasis</i>: nystatin PO for 7 days^(b) If necessary, gastric tube feeding.
--	--

(a) Zinc supplementation is unnecessary if the child is receiving nutritional treatment with F-75 or F-100 milk, Plumpy'Nut® or BP-100.

(b) If nystatin is not available, gentian violet 0.25% may be applied 2 times daily for maximum of 5 days.

AND

Treatment of malnutrition if any	Follow the protocol for managing malnutrition (RUTF).
---	---

AND

Treatment for other complications if any	<ul style="list-style-type: none"> • <i>Seizures</i>: diazepam if generalised seizures • <i>Malaria</i>: Antimalarials that are effective in the region.
---	---

See [Appendix 13](#) for doses according to weight or age.

5.4.1 Standard treatment

Paracetamol should be given orally, if possible. The IV route is used only in case of high fever in a child who is vomiting repeatedly or whose consciousness is impaired (lethargy or coma). IV paracetamol is no more effective than oral paracetamol, and is more complicated to administer (infusion every 6 hours).

Five-day antibiotherapy (amoxicillin PO, except if resistance is known in the area) is given to children under 5 years, to prevent potential complications. If a child under 5 years has nonsevere pneumonia or acute otitis media, there is no change in therapy since the first-line treatment for these infections is the same as the standard antibiotic therapy already routinely administered. For severe pneumonia, replace amoxicillin with the ceftriaxone + cloxacillin combination.

Clearing the upper airways: blow the child's nose to prevent congestion and secondary respiratory infection and improve the child's comfort (especially during breastfeeding) and sleep. Nasal lavages with 0.9% sodium chloride solution may be used in the event of significant nasal discharge ([Appendix 15](#)).

Patients without ocular involvement should receive one dose of vitamin A on 2 consecutive days except pregnant women (ask the patient).

If the patient has corneal involvement or Bitot's spots, give 3 doses of vitamin A, rather than 2 (the third dose is administered some time after the first two doses, on D8).

When appropriate to the situation, give children under 3 or 5 years who are not malnourished ready-to-use food (500 kcal daily) during their hospitalisation and for 2 weeks after discharge.

5.4.2 Management of complications^a

Respiratory complications

- In all cases:
 - check to make sure that the upper airway is clear;
 - respect the position the patient chooses for breathing – usually sitting or half-sitting. Do not lay him down while he is having trouble breathing;
 - set up a pulse oximeter, if available.
- In the event of cyanosis, laboured breathing (e.g., nasal flaring), or $SpO_2 < 90\%$: oxygen mask with sufficient flow to bring the SpO_2 back above 90%.
- In the event of audible wheezing (with or without a stethoscope): aerosol bronchodilator (salbutamol).
- In the event of severe pneumonia: immediately start parenteral antibiotics.
- In the event of benign or moderate croup:
 - monitor the child for signs of worsening (regular assessment of respiratory rate, indrawing?, stridor?);
 - agitation and crying exacerbate the symptoms: keep the child calm, reassure him, place him in his parent's arms or in a seated position to help him breath;

- the symptomatic treatment is standard: hydration, antipyretic, decongestion, etc.
- In the event of severe croup:
 - the child is placed under intensive monitoring until symptoms resolve;
 - administer one dose of dexamethasone IM. The anti-inflammatory effect begins in 30 minutes to 2 hours, and lasts about 24 hours. Give only a single dose;
 - nebulised epinephrine (adrenaline) is used to relieve symptoms while waiting for the steroids to take effect. It rapidly improves symptoms (in 10 to 30 minutes), but effect does not last long (about 2 hours). Symptoms may recur (rebound effect). Nebulisation can be repeated once, on medical prescription only. See [Appendix 16](#) for administration and monitoring;
 - standard symptomatic treatment: hydration, antipyretic, decongestion, etc.;
 - keep the child calm, in his parent's arms, to reassure him and help him breath.

Acute otitis media

If there is discharge from the ear, keep the ear clean by wiping the external auditory canal with dry cotton wool.

Stomatitis that prevents eating

Gastric tube feeding (F-100 milk) is needed as long as the child cannot eat. Check daily to see if the tube is still necessary; remove it as soon as possible.

Seizures

- If the patient is having a generalised seizure, take the usual measures (protect him from injury, lay him on his side). Use intrarectal diazepam if the seizures do not resolve spontaneously.
- Look for the cause of possible the seizures (e.g. hyperthermia, hypoglycaemia, severe malaria in endemic areas [perform a rapid test]) and assess the risk of recurrence.

See [Appendix 13](#) for doses according to weight or age.

5.4.3 Patients transferred to a hospital

Depending on the distance, the time needed for the transfer, and the complications identified at the examination:

- Administer the first dose of amoxicillin PO^b.
- Administer the first dose of paracetamol PO, especially if the fever is high, or if the child had a seizure.
- If the patient is dehydrated, he should be able to drink ORS while being transferred.
- If the patient is severely dehydrated, place a IV line and transfer the patient when stable.
- If the patient has a corneal lesion: protect the eye with a dry dressing.

Always send the patient with a transfer form indicating the reason for the referral and treatments administered.

5.4.4 Advice for parents on hospital discharge

1) Ask parents to:

- make the child drink, and give smaller, more frequent meals or breastfeed more frequently;
- keep his eyes clean, blow his nose frequently.

2) Instruct parents on how to use the medications and nutritional supplements. Make sure that they understand the instructions. Provide the drugs, supplies (cotton), supplements needed to do the rest of the treatment at home.

3) Ask them to bring the child back in if his condition worsens; for example, if he cannot drink or nurse, or is vomiting, if his consciousness is impaired (he is difficult to awaken), if he has respiratory problems, or if the diarrhoea recurs.

4) Explain that after measles, complications can still occur and that they should bring the child back in right away if he does not recover completely.

Footnotes

(a) See also the: Pocket book of hospital care for children: guidelines for the management of common illnesses with limited resources. World Health Organization, 2005.

<http://whqlibdoc.who.int/publications/2005/9241546700.pdf>

(b) If the patient has severe pneumonia and ceftriaxone and cloxacillin are available peripherally, administer the first dose before transferring the patient.

5.5 Key points

- Complications of measles are common. Most deaths are due to complications. They should be routinely looked for on clinical examination.
- Early management of uncomplicated cases helps reduce complications. Early management of complicated cases reduces the case fatality and sequelae.
- Uncomplicated cases are treated as outpatients. Complicated cases are admitted as inpatients. Hospitalised patients should be isolated from other patients.
- During the post-measles period, children are more vulnerable to infections.
- No prophylactic treatment for close contacts.

Chapter 6: Mass vaccination campaign

[6.1 Campaign timetable](#)

[6.2 Needs estimation](#)

[6.3 Human resources](#)

[6.4 Schedules](#)

[6.5 Campaign logistics](#)

[6.6 Vaccination quality and safety](#)

[6.7 Key points](#)

6.1 Campaign timetable

Time spent planning activities is time saved during the campaign. Good preparation reduces the chances of unforeseen problems and increases the quality of the operation. Planning errors are difficult to correct once the campaign is underway.

In epidemic situations the population is often keen to get vaccinated and delays due to poor planning (e.g., vaccine shortages, cold chain failures and incorrect practices) can cause tension or even rioting.

One of the first steps is drawing up a timetable, which shows the timing of the preparation, implementation and evaluation activities for the campaign.

One of the first steps is drawing up a timetable, which shows the timing of the preparation, implementation and evaluation activities for the campaign ([Appendix 17](#)).

This work plan is used to coordinate the actions to be implemented within a given time frame. It should be followed and adapted to the needs.

- The timetable should specify:
 - the list of tasks to be done by category (committees, human resources, awareness-raising and social mobilisation, etc.);
 - the name of the person responsible for each task;
 - the schedule of activities.
- Using the timetable:
 - allows specific, detailed activity planning;
 - ensures that nothing is forgotten when implementing activities;
 - ensures that everyone knows his or her role;
 - allows day-to-day monitoring of preparations;
 - allows verification that each task has been done in due time;
 - permits responsiveness when additional resources are needed.

Ideally, emergency vaccination activities can be set up in 8 to 10 days, 15 days maximum.

The campaign begins only when all preparations are complete:

- vaccines and supplies are in place (no just-in-time operations);
- surveillance tools are available;
- teams are trained;
- logistics are ready (cold chain, site storage and equipment/supply, waste collection and disposal system, transport);
- population has been informed: see [Chapter 2](#).

6.2 Needs estimation

6.2.1 Vaccines

Number of vaccines

The vaccine needs ([Appendix 18](#)) are estimated based on:

- the target population (population to be vaccinated);
- the objective (> 90% in an epidemic situation);
- the wastage factor: estimated at 1.17 during a vaccination campaign (= 15% wastage); If 100 doses are needed to vaccinated 85 people (85% utilisation rate), then 117 doses need to be ordered to vaccinate 100 people;
- the buffer stock: estimated to be from 10 to 25% (depending on the number of people to be vaccinated and the reliability of the population figures).

Example: to vaccinate all children ages 6 months - 15 years in a total population of 50,000, calculate the number of vaccine doses to order as follows:

1. Total population		50,000 people
2. Calculate target population (6 months - 15 years)	x 40%	20,000 people
3. Vaccination coverage objective	x 100%	20,000 people
4. Add 15% for wastage	x 1.17	23,400 doses
5. Add a buffer stock (estimated at 25%)	x 1.25	29,500 doses
6. Estimate the storage volume (in litres) ^(a)	x 2.1 cm ³ /1000	62 litres

(a) *In this example, 1 dose = 2.1 cm³ (1000 cm³ = 1 litre)*

To prevent errors due to different vaccine presentations, always express needs as the number of doses and not the number of vials (that is, 1,000 doses, not 100 vials).

Vaccine storage volume

When planning, always consider the volume taken up by:

- vaccines: for cold chain storage needs;
- diluents: they take up the same volume as vaccines, but do not go into the cold chain until 12 to 24 hours before use.

Presentations may vary. The average volume per vaccine dose can range from 2 to 2.5 cm³. Check the volume with the suppliers or, if that is not possible, use the standard volume determined by the WHO (3 cm³ per dose).

Example: a box of fifty 10-dose vials (500 doses) of lyophilised vaccine takes up a total of 18.6 cm x 9.8 cm x 5.8 cm = 1,057 cm³.

Thus the volume taken up per dose is 2.1 cm³ (1,057/500).

6.2.2 Medical supplies

Injection supplies

Injection supply needs are based on the number of vaccine doses needed ([Appendix 18](#)).

- Count 1 dilution syringe and needle per vial.
- Use only auto-disable syringes (ADS) to administer the vaccine. Allow 5 to 10% wastage due to handling errors.

Other supplies

- 500 g of cotton wool for every 500 vaccinations
- For vaccinators only: 1 pair of single-use gloves for every 50 injections
- To collect used syringes/needles, use 15-litre safety boxes (about 400 syringes), rather than 5-litre safety boxes (about 100 syringes), if possible.

In sparsely populated areas where fewer people are vaccinated each day, the safety boxes will only be partially filled, so allow for more safety boxes (15% more, for example) for a rural vaccination campaign.

6.2.3 Cold chain

Needs

Needs in terms of the active cold chain (which makes things cold) and the passive cold chain (which keeps them cold) are estimated based on:

- the volume of vaccines to be stored in the refrigerator (expressed in litres);
- the freezing capacity (in kg/24 hours) and storage volume needed for the ice packs;
- the vaccination schedule;
- the cold chain equipment needed at each vaccination site and the maximum number of sites that will be operating simultaneously;
- the cold chain equipment needed for each supervision team and the maximum number of supervision teams working simultaneously;
- existing cold chain equipment available for the campaign.

Cold chain	Use	Equipment needed	Information needed
Active	Storing vaccines	<ul style="list-style-type: none"> • Refrigerators • Thermometers • T° monitoring sheets • Freeze-tag® 	<ul style="list-style-type: none"> • Total volume of vaccines for the campaign • Electricity (stability, duration, reliability, security)
	Freezing ice packs	<ul style="list-style-type: none"> • Freezers • Ice packs • Thermometers • T° monitoring sheets 	<ul style="list-style-type: none"> • Freezing volume and capacity needed for the duration of the campaign • Electricity
Passive	Transporting vaccines/diluents to vaccination sites and storing them there	<ul style="list-style-type: none"> • Cold boxes + thermometers • Vaccine carriers • Ice packs 	<ul style="list-style-type: none"> • Number of cold boxes and vaccine carriers per vaccination team • Number of vaccination teams and schedule • Duration of the campaign

Inventory of available equipment

While a cold chain sometimes needs to be set up quickly from scratch, equipment is often available locally and simply needs to be supplemented. Inventory the equipment available at the various levels before ordering. Verify that the equipment is actually in place and works.

- Refrigerators and freezers: check the available capacities and specify the model, brand, number and energy type. Consider and evaluate other available refrigeration and freezing options such as renting or borrowing equipment, or places that make ice (fisheries, businesses, markets, ice cream manufacturers, etc.).
- Check the electrical systems for reliability, accessibility, quality and security. Check the power and voltage and any potential fluctuations during the day.
- Draw up a list of available generators and indicate which type of fuel they use (e.g., petrol or diesel).
- Cold boxes, vaccine carriers and ice packs: get an inventory of existing equipment at each health care facility. Verify the condition and indicate the type, brand and model and how many there are. Be sure to specify the number of ice packs by volume (0.3-litre, 0.4-litre or 0.6-litre).
- Thermometers, twice-daily monitoring sheets and other cold chain monitoring tools.

See Appendices [19](#), [20](#), [21](#) and [22](#).

Cold chain for teams/vaccination sites

Correct storage during transport and at vaccination sites is essential to ensure vaccine quality.

Campaigns require large amounts of ice. The total number of ice packs needed per day is calculated based on the vaccination and supervision team needs ([Appendix 23](#)):

- For one vaccination team:
 - one RCW25 cold box for storing vaccines and diluents (one cold box may be enough if two teams work at the same site);
 - one vaccine carrier for intermediate storage of vaccines and diluents.
- For one supervision team: one cold box (spare vaccines and diluents).

To allow rotation (using/freezing), double the number of ice packs needed per cold box and vaccine carrier.

For calculating storage volume: one frozen 0.6-litre ice pack takes up about 1 litre.

Estimate the total storage volume needed and the freezing capacity (in kg/day) so that there are enough ice packs on the first day of the campaign to ensure a continuous supply for the entire campaign. Always add a safety margin.

6.2.4 Vaccination kit

The kit- and module-based supply system simplifies needs calculation and procurement. All of the materials needed are delivered at the same time.

The KMEDKIMM3-- kit ([Appendix 24](#)) allows set-up of an emergency vaccination campaign for 10,000 people with 5 vaccination teams.

The kit contains medical and logistics modules.

It can be ordered complete or by module, depending on the strategy chosen, the human resources available and local constraints and resources.

There are no vaccines in the vaccination kit. They must be ordered separately.

6.2.5 Data collection tools

The data collection system should be in place before the campaign begins. The main data entry tools are prepared and the staff trained in their use.

Vaccination card

At a minimum, the vaccination card should include the last name, first name, age and address of the person vaccinated and the vaccination date. Other information is sometimes requested, such as lot number, vaccine name, gender, vitamin A, etc.

The vaccination card is the only proof of vaccination and should be kept. Different models may be used:

- National immunisation programme card: in this case, make sure that the dose administered during the campaign is clearly identified (specific box or stamp indicating the vaccine and the date).
- Card specific to the current vaccination campaign ([Appendix 25](#)). This should be as simple as possible.

Daily tally sheet

This is used to keep a count of the day's activity ([Appendix 26](#)). The recorder checks off each dose administered by age group (e.g., 6-8 months, 9-11 months, 12-59 months or 5-15 years).

This sheet should also include:

- the vaccination location, site and date;
- the team identifier (for later verification, if needed);
- the number of vaccine and diluent vials received and the lot numbers (for traceability in case there is a problem);
- the supplies received and remaining at the end of the day (for estimating the supplies used);
- the status of the vaccine vial monitors (VVMs) at the end of the day.

Summary sheets and summary table

Using the tally sheets from the vaccination teams, supervisors compile the data by day or by location on summary sheets ([Appendix 27](#)). At the end of the campaign the summary table is used to analyse the results and draft the final report.

6.3 Human resources

6.3.1 Human resource needs

Vaccination campaigns require significant human resources. Be careful not to monopolise the available personnel, thereby compromising regular patient care activities.

The number of teams needed is based on the size of the target population, the expected output per team and the optimal campaign duration ([Appendix 28](#)):

- At best, in a densely populated area, a well-trained vaccinator using auto-disable syringes prepared by 2 preparers and working 6 hours a day can vaccinate 1000 to 1200 people a day.
- In sparsely populated areas, a team can vaccinate 300 to 600 people a day.
- The optimal campaign duration per location is estimated based on the number of vaccinators, the personnel available and the expected output.

Note: this planning is theoretical and should be adjusted according to the context and experiences with prior campaigns.

6.3.2 Core vaccination team

The standard core vaccination team has at least six posts and is centred on one vaccinator ([Appendix 29](#)).

The number of people needed for each post depends on the context:

- In densely populated areas (urban areas and refugee camps) where a lot of people are expected, vaccination proceeds at a sustained pace. The vaccinator is supported by a large team to ensure a continuous flow.
- In rural areas, the crowds are smaller and the pace of vaccination slower. The team composition is adapted to the target population and expected output.

The key posts (vaccinators, preparers and recorders) are always entrusted to regular qualified or trained personnel. Recording is a key post, since any errors there will affect the vaccination coverage calculation.

The other posts (security, registrars, vitamin A dispenser) require fewer qualifications and may be entrusted to locally recruited, trained and supervised personnel.

Do not underestimate the amount of time needed to fill out a vaccination card.

Registration can be a bottleneck and slow the flow of people considerably.

Table 6.1: Core team makeup as a function of the context, and each person's tasks

Post	Qualification	Tasks	Number of people	
			Urban	Rural
Vaccinator	Nurse, midwife, health worker	<ul style="list-style-type: none"> Cleans the skin with clean water. Administers vaccinations. 	1	1
Preparer	Health worker, student nurse	<ul style="list-style-type: none"> Reconstitutes the vaccines. Fills the syringes. 	2	1
Registrar	People who can read and write: teacher, administrative worker, etc.	<ul style="list-style-type: none"> Fills out the vaccination cards. Writes or stamps the date. 	2 to 3	1
Recorder	People who can read and write: teacher, administrative worker, etc.	<ul style="list-style-type: none"> Fills in the tally sheet. 	1	1
Crowd control officer	Chief of village, volunteers, police	<ul style="list-style-type: none"> Informs the population. Selects for the target population Organises the queues. Provides crowd control and security at the site. 	4 to 6	2 to 4
Vitamin A dispenser	Volunteers	<ul style="list-style-type: none"> Administers an age appropriate dose of vitamin A. 	1	1

Depending on additional activities:

Post	Qualification	Tasks	Number of people	
			Rural	Rural
MUAC measurer	Health worker, student nurse	<ul style="list-style-type: none"> Measures the mid-upper arm circumference on children under 5 years of age. Directs the child according to the result. 	1	1
MUAC recorder	People who can read and write: teacher, administrative worker, etc.	<ul style="list-style-type: none"> Fills out the tally sheet. 	1	

6.3.3 Supervision team

The supervision team monitors the quality of the campaign.

It provides the teams with constant, direct support, observes their work, corrects errors in real time and helps with solving problems and when the volume is high.

Ideally, it consists of a medical supervisor ([Appendix 30](#)) and a logistics supervisor ([Appendix 31](#)). The medical and logistics supervisors each get a vehicle and driver.

In urban areas, a supervisor can simultaneously manage teams at several sites. With more than three sites, however, monitoring and coordination become difficult.

In rural areas, the medical supervisor cannot directly oversee each site and so focuses more on general organisation. The first priority is monitoring less experienced teams or sites with special constraints.

On the first day of the campaign, site openings are staggered (one after the other rather than simultaneous); this allows the medical supervisor to supervise the teams at each site to make sure that activities start up properly.

The logistics supervisor focuses primarily on-site organisation, the cold chain and transport. He supports one or two supervisors (no more than six sites at a time).

There should be a daily meeting. This allows all necessary information to be transmitted to the health officials and local authorities, and feedback for the teams the next day.

6.3.4 Training

Training for medical and logistics personnel is essential, and should be done before the start of the campaign.

The training plan includes the training objectives, the course description (objectives, length, number of participants, teaching methods and content) and evaluation.

Job descriptions are established for each team member. These serve as a basis for training, and are distributed to the staff with the manuals and other practical documents.

Practical interactive sessions (simulations, case studies and exercises) should be held the day before the campaign with a simulation at a site, if possible, using the actual supplies and equipment. This allows last minute adjustments and facilitates first day start-up.

Best practices and what to do in case of an accidental exposure to blood (AEB) are an integral part of staff training.

The film [Organising an emergency mass vaccination campaign](#) is good tool for planning and organising a campaign and for training the teams.

6.4 Schedules

6.4.1 Vaccination schedule by location

See [Appendix 17](#).

The vaccination schedule by location provides a prioritised timetable of activities. The various planning steps for the campaign are done concurrently.

Table 6.2: Steps in planning a vaccination campaign

Step	Information needed	Take into account
Estimate the target population to be vaccinated for each location	<ul style="list-style-type: none"> • Number of people to be vaccinated • Vaccine quantity and volume 	<ul style="list-style-type: none"> • Towns/cantons • Health care facilities
Estimate the time needed to vaccinate the target population in each location (Appendix 28)	<ul style="list-style-type: none"> • Optimal duration of vaccination • Number of days scheduled to achieve vaccination coverage + safety margin (rest breaks, unforeseen events, etc.) 	<ul style="list-style-type: none"> • Expected team output in urban and rural areas • Previous experience • Accessibility and security
Estimate the number of teams needed and available	<ul style="list-style-type: none"> • Number of teams • Composition of teams • Discuss regular staff and people who will be hired locally. 	<ul style="list-style-type: none"> • Available personnel, qualifications and previous campaign experience • Job descriptions
Determine the number of vaccination sites and where they will be located	<ul style="list-style-type: none"> • Target population to be vaccinated for each location • Population density • Size of the area covered • Accessibility of the site 	<ul style="list-style-type: none"> • Acceptability to the population • Access roads, distance and estimated travel time
Discuss the different strategies and choose the most appropriate ones	<ul style="list-style-type: none"> • List the different approaches^(a), identifying the advantages and disadvantages. 	<ul style="list-style-type: none"> • Logistical, human and financial resources • Security
Set up the schedule	<ul style="list-style-type: none"> • Strategy chosen • For each location: duration of the vaccination, number of teams, number and location of sites 	<ul style="list-style-type: none"> • Reasonable duration • Order delivery time to the field • Constraints and degree of urgency

(a) For example, vaccinate urban area first and then rural, all locations at the same time or one after the other, northern and then southern area, etc.

Copy the essential information (target population, duration, number of teams, number of sites, etc.) onto a map of the region.

Other information to consider:

- order delivery time and campaign implementation time;

- events (market days, public holidays, elections, food distributions, etc.);
- security: road travel times, authorisation;
- available resources (material and financial).

The campaign should be done quickly, but always allow extra time for unexpected events and rest time for the teams. Allow a one-day break between vaccination locations for taking stock (equipment and results); during this time the logistics team prepares the equipment and next sites, and public information begins. Consider previous experiences.

The schedule can be adjusted each week depending on:

- the results of the vaccination (e.g., if the coverage obtained is < 80%, consider extending the campaign with a limited number of teams);
- the updated epidemiological data (epidemic curve);
- any other new developments (security, lack of availability of a team, very bad weather, etc.).

6.4.2 Team schedules

See [Appendix 17](#).

The daily team schedule is drawn up based on the vaccination schedule by location. It details the location, site and duration and is used for:

- organising team preparation and training;
- preparing the cold chain, transport, site preparation and set-up, and supply for the teams at the sites;
- planning public information.

6.5 Campaign logistics

The importance of logistics during a campaign is often underestimated. Good coordination between the medical and logistics teams in planning, organizing, implementing and monitoring activities is essential for:

- locating, organizing and managing the central storehouse;
- the cold chain;
- identifying and setting up the vaccination sites;
- supply;
- transport;
- communications;
- waste collection and disposal.

6.5.1 Central storehouse

Location

The best option is to have the cold chain, medical stock, logistics stock, vehicles and fuel all in the same place. All of the teams are supplied from this central point.

If it is impossible to find a large enough space, make sure to find spaces that are near each other to facilitate organisation and supervision.

If possible, choose a large city and a location that is accessible at all times, with round-the-clock electricity to ensure continuous cold production (refrigeration and freezing).

Layout

The central storehouse is laid out in five sectors of varying floor space:

- Active cold chain (freezers, refrigerators and cold room): 0.3 m³/1,000 doses
- Passive cold chain: 2.85 m²/vaccination team
- Renewable medical equipment and supplies: floor space depends on estimated needs
- Logistics equipment and supplies: floor space is a function of estimated needs
- Vaccination module preparation area (2.5 m²/team)

Management

Stock management is entrusted to a trained manager, aided by one or more assistants. Each person's tasks are clearly defined. One of the assistants should be able to fill in for the manager in case of absence.

The practical details of stock management and the schedule of activities (ordering, distributing and monitoring stock) should be established in advance in a way that distributes the workload appropriately.

Management tools

Stock card

The stock card ([Appendix 32](#)) is essential for inventory monitoring and product traceability. Each item (vaccines, diluents, drugs, supplies and kits) has its own stock card, which is updated every time items go in or out.

The card must include:

- The International Non-proprietary Name (INN) of the product, the form, dosage, lot number and expiry date. Quantities of vaccines are always expressed in number of doses, not in number of vials.
- Stock movements (stock in and origin, stock out and destination) and dates. Enter each movement on its own line, even if there are several movements in the same day.
- Orders placed and dates. When an order is placed, the date, name of the supplier and quantity ordered are entered but the “STOCK” column remains unchanged. When the order arrives, the quantity received is entered in the “IN” column and the “STOCK” column is updated.
- Inventories and dates. If the cards are kept correctly, the “STOCK” column corresponds to the inventory. Any differences should be investigated.

The card may also include other information, such as:

- buffer stock/maximum stock;
- other storage locations for the product;
- unit price.

To prevent inventory shortages, an alert threshold is defined for each “sensitive” item and noted on the stock card. It is calculated based on the consumption, the supply time and a reserve.

For example, if it takes a product one month to arrive after being ordered, the alert threshold is equal to one month’s consumption + a one-month reserve = 2 months.

Monitoring table

In addition to stock cards, a monitoring table for sensitive items (vaccines, auto-disable syringes, dilution needles and syringes and safety boxes) should be displayed and updated daily.

Delivery forms

Delivery forms ([Appendix 33](#)) are pre-printed to make the work easier and prevent transcription errors. Signed copies of these documents are kept by the storekeeper and person in charge at each site.

6.5.2 Cold chain

Centrally

There should be a generator in case of power outages (or a backup generator if the electrical power source is a generator).

A technician (aided, if necessary, by an assistant) is responsible for:

- installing refrigerators and freezers and turning them on at least 24 to 48 hours before vaccines arrive;
- appliance operation, maintenance and repair;
- monitoring temperatures;
- preparing the cold boxes and vaccine carriers for transport to the sites (cleaning and loading the ice packs and placing the thermometer in the cold boxes);
- freezing the ice packs.

Note: ice packs should be frozen several days before the campaign starts, and there should be enough stock for the entire campaign. To freeze ice packs more quickly, freeze half of them in the morning and the other half at night.

A pharmacist (or member of the medical staff) is responsible for:

- managing the stock of vaccines and diluents;
- preparing the vaccines and diluents that are sent to the vaccination sites daily;
- checking the unused vaccines and diluents at the sites, which are put back into stock.

Notes:

- All of the vaccines sent to a vaccination site should be from the same lot, and the same for diluents. Do not mix products from different lots.
- During the campaign, diluents should be chilled (in a refrigerator or cold box) for at least 12 hours before use.

Vaccination sites

At the sites, vaccines are stored in a cold box and/or vaccine carrier.

The ice packs should be replaced:

- once a day for vaccine carriers;
- every other day (or more often, depending on the outside temperature) for cold boxes.

Note: the time needed to re-freeze ice packs can be reduced by storing the partially-thawed ice packs in an insulated container.

For vaccine storage at the site, see [Appendix 34](#).

6.5.3 Vaccination sites

Distribution and number

The number of sites is calculated based on the size of the target population.

Their distribution depends on the population density, the size of the area and the accessibility, but they should cover all neighbourhoods/villages. In densely population areas, one site can cover up to 15,000 residents.

Note: the greater the number of sites, the more challenging the logistics (transport, supply, cold chain, etc.). While some sites can accommodate two teams, with more than two teams the crowd becomes too hard to control. It is better to open another site.

Selection criteria

Depending on the context (rural area, urban area, refugee camp), a vaccination site can be a community hall, school, place of worship, tent or shaded outdoor area. Avoid health care facilities so as not to disrupt normal activities.

- The site must be easily accessible (main roads).
- The area should be large enough to allow a smooth flow of people to be vaccinated and a comfortable, practical layout for the teams. Too large a site is hard to organise (confusion on where to go, security, etc.).
- The waiting area should be shaded and large enough for a roughly 50-metre queue.
- Using a building with a separate entrance and exit is essential in preventing jostling.
- Use an enclosed site (walls or fences), if possible, because it is easier to channel the population when there is a large crowd.

Organizing the site

Prepare the site and all the necessary equipment the day before the campaign starts. Security and a smooth flow of traffic are essential, especially during the first 2 days when the crowds are largest. Do not start the vaccination until everything is ready.

Set-up

- Outdoor sites should be used in rural areas only.
- If the site is not enclosed, mark it off using a rope or safety fencing.
- Organise the queues using rope or barrier tape. Allow about a 50-metre queue, narrow enough to allow only one person at a time to pass. A line that zigzags is better than a straight line, because it reduces the press of the crowd.
- Provide drinking water in the waiting area, as some people may come from far away.
- If the site is very large, mark off the entire flow path inside with ropes, from the entrance to the exit, and position security guards to ensure a smooth flow of people.
- Vaccination cards are filled in at the entrance to the site.
- The preparers' work area should be separated somewhat from the flow of people, next to the vaccinator.
- The tally sheets are completed right after the vaccination.
- Equipment and supplies should be out of the population's reach, but easily accessible to the preparers.
- The waste storage area should be some distance away and protected.

Figure 6.1: Layout of a 2-team vaccination site

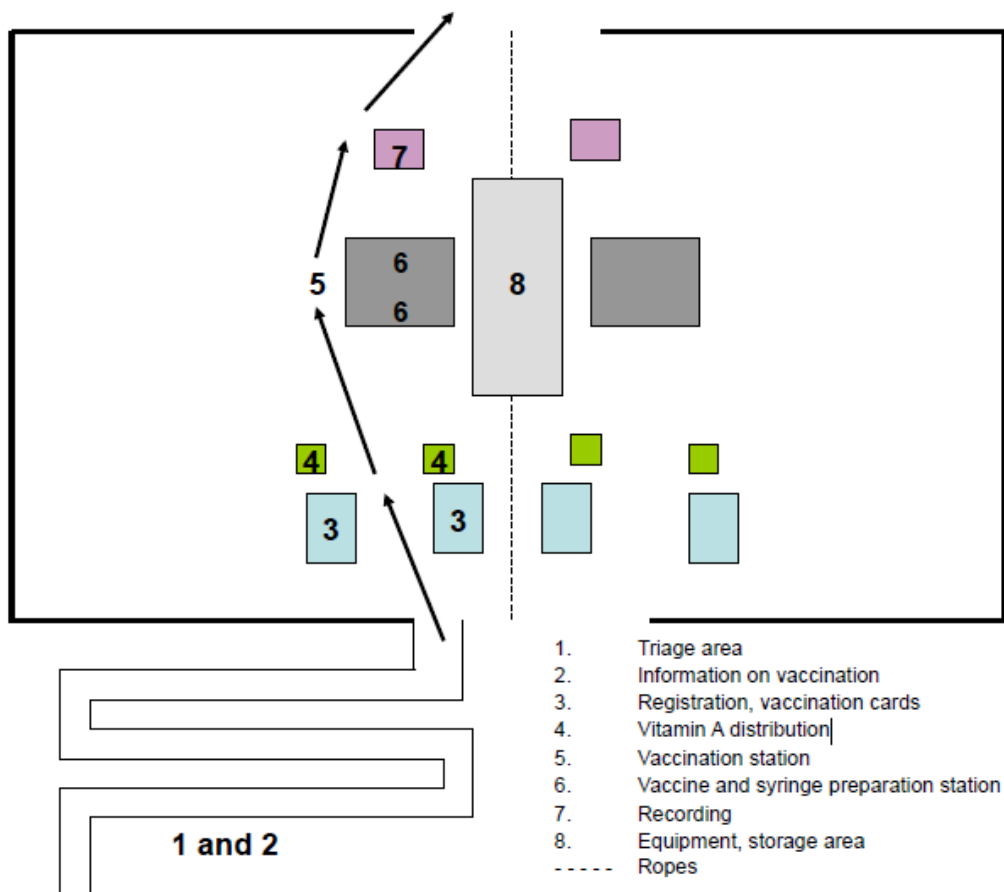

Also see [Appendix 36](#) for a summary of how a vaccination site is organized.

6.5.4 Supply

A module-based supply system facilitates preparation and distribution. The modules are prepared ahead of time at the central storehouse. Provide 2 types of modules:

- Equipment for one vaccination team ([Appendix 37](#));
- Equipment for one supervision team ([Appendix 38](#)).

The modules contain:

- Renewable medical supplies and vaccines for one day. This module is prepared in advance at the central storehouse and given to each team each day. The unused stock is inspected every evening. If it is equal to or greater than the contents of one module, there is no need to resupply.
- Equipment (medical and non-medical) that is given to each team the first day of the campaign and returned at the end of the campaign. Check that the box is labelled with the team number to which it belongs.

The supplies given to each team are recorded each day, making it possible to count up all the supplies that were used at the end of the campaign, and to calculate the indicators for the evaluation ([Appendix 39](#)).

6.5.5 Organising transport

Appropriate (in number and type) and reliable transport is essential to a smoothly-running campaign.

Estimating transport needs

- Vehicle needs are estimated based on:
 - the number and location of sites;
 - the number of teams and the duration of the campaign;
 - the number of supervision teams and their schedule;
 - the condition of the roads (urban and rural areas);
 - how supply is organized.

Have one lorry for delivering supplies.

Have cars, motorcycles, bicycles or other means of transport for deploying vaccination and supervision teams.

If possible, have one vehicle exclusively for waste collection.

- Fuel needs are estimated based on:
 - the average consumption per vehicle;
 - the estimated mileage (anticipated schedule);
 - the condition of the roads.

Inventory of available resources

- Cars and lorries:
 - type (break, minibus, etc.) and model (city or all-terrain);
 - operating condition and reliability;
 - type of fuel and fuel consumption;
 - number of seats and possibility of transporting supplies;
 - assignment of a driver or not;
 - lending agency or organization, duration and conditions of loan;
 - rental conditions (cost, insurance, etc.).
- Fuel: type and availability (quantity, location), quality and cost.

Team transportation

Transportation must be appropriate to the teams' activities (vaccination, supervision, logistics or mobilisation) and the field conditions (distances, road conditions, etc.). Means of transport may be obtained from the health or administrative authorities and partners, or rented for the duration of the campaign.

In urban areas, the vaccination teams get to the sites on their own, or group transport is arranged.

The opening times for the different sites can be staggered to optimise and rationalise transportation for the teams.

In rural areas the sites are often remote and teams must be self-sufficient. Each team needs its own vehicle.

The supervision and logistics teams must be completely self-sufficient and have their own vehicle.

Transport and delivery of equipment and supplies

There are several possibilities:

- **Before or at the start of the campaign**

All vaccination supplies can be stored on-site before the site opens, or each team can bring its supplies when it opens the site.

When setting up the site, it is generally possible (and preferable) to procure certain items (tables and chairs) on-site.

- **During the campaign**

The teams bring their supplies with them each day, or the supplies are delivered to the teams each day (or every two or three days) from the central storehouse or some intermediate, outlying storehouse when distances are large.

Whatever the options chosen, supplies must be available at the sites at all times.

Automobile fleet monitoring tools

These tools must be put in place before the campaign starts. They facilitate fleet management: vehicle monitoring/allocation table; fuel consumption monitoring table ([Appendix 40](#)).

6.5.6 Communications

The use of mobile phones, radios or other means of communication facilitates organisation and reduces travel.

6.5.7 Waste management

Mass vaccination campaigns generate a large amount of waste. The waste circuit must be well-organized and safe at every level. Waste collection and disposal should be supervised, and be evaluated when the campaign is over.

Before the campaign starts:

- Inquire about the national policy on waste treatment and disposal.
- Estimate the expected volume of each type of waste.
- Evaluate the technical resources needed (reduction, incineration, burial, encapsulation; personal protective equipment, etc.) based on the estimated volumes.
- Determine the resources available in the area in question (equipment, existing or potential sites).
- Decide on the general organisation of treatment/disposal: centralised and/or on-site, temporary storage, transport, etc.
- Determine the number of people needed, their duties, and the training needs (safe handling of waste, AEB procedures, etc.).

Organisation of waste treatment/disposal

Centralised system

All waste is transported to a central site, where it is disposed of.

Centralising all waste at one site that has effective treatment/disposal resources is the best option.

To store waste at a vaccination site prior to transport to the disposal site, provide a secure covered area not accessible to the population.

During transport to the disposal area, staff should use the same protective equipment as for all other handling.

As far as possible, one vehicle should be allocated specifically to transporting waste. If the situation does not allow this (number of sites, number of teams or duration), make sure that personnel do not come in contact with waste during travel.

Safety boxes should be transported in a way that prevents any risk of needle stick injury or spill (properly closed, boxes taped shut, padlocked metal trunk, etc.).

To store waste at the disposal site, provide a secure area (covered, enclosed and locked).

On-site disposal

It may be that not all waste can be transported to the central disposal site. In that case, safe disposal of some waste is possible at a temporary site inaccessible to the population.

Soft waste can be disposed of right at each vaccination site.

Safety boxes should preferably be disposed of at a central location. If transporting them is too complex and/or dangerous, however, they can be destroyed on-site.

Note: empty or partially used vaccine and diluent vials are always collected, centralised and destroyed at a single controlled destruction site. They should never be destroyed on-site.

Table 6.3: Advantages and disadvantages of waste disposal strategies

	Advantages	Disadvantages
Central	<ul style="list-style-type: none"> • Better control • Less risk to the population • Fewer people to train 	<ul style="list-style-type: none"> • Requires significant transport resources/budget • More handling • Requires a protected storage location for waste awaiting treatment.
On-site	<ul style="list-style-type: none"> • Less or no transport • Less handling 	<ul style="list-style-type: none"> • Requires finding an appropriate nearby location • Harder to control due to multiple sites • Requires multiplication of means (reducers, protective equipment, etc.) • Many people to train/supervise at the sites • Risk that used material will be salvaged • Team forced to stay on-site until all waste is disposed of or delegate this with no guarantee of appropriate treatment

For disposal techniques, see [Public Health Engineering in precarious situations](#), MSF.

In all cases, teams should leave never the vaccination site until all waste has been taken away or destroyed.

Sorting waste

Waste is sorted by type as it is produced, and gathered in a single location.

Table 6.4: Waste management by type

Type of waste		Collection	Disposal
Soft waste	Gloves, cotton wool, needle caps, packaging, etc.	Rubbish bin	Burned in a volume reducer/incinerator and ashes buried If bags are used, make sure that they fit into the volume reducer/incinerator's combustion chamber when they are full.
Sharps	ADS, dilution syringes and needles	In safety boxes <i>Follow the assembly and use instructions on the box. Never fill beyond the fill limit.</i>	Burned in a safety box reducer and the remnants encapsulated
	Empty vials (vaccines and diluents)	In their original packaging or in separate containers (one for vials, one for diluents)	Crushing and/or encapsulation
Other high risk waste	Vials containing reconstituted vaccine	In vaccine carriers <i>These are sent back to the central storehouse where they are disposed of.</i>	Encapsulation

6.6 Vaccination quality and safety

6.6.1 Vaccine quality

At each level (capital, peripheral areas):

- For vaccines: check the name, where the delivery originated, the label, the expiry date, the quantity delivered and the lot number.
- The composition and volume of diluent can vary. Check that the diluent supplied corresponds to the vaccine (type, labelling, quantity and expiry date) and use only diluent provided by the manufacturer. In case of accidental loss of diluent, contact the pharmacist or manufacturer for advice on what to do.
- After a vaccination session, unused vials of reconstituted vaccine absolutely must be thrown away.
- The first time a vaccine is received or when receiving a vaccine from a different manufacturer, read the package insert to learn the specifics about the product.
- Examine the products (the diluent should be clear and have no sediment).
- Check to make sure there was no cold chain failure during vaccine transport: the vaccine vial monitor ([Appendix 41](#)), thermometer and temperature sheet, and Stop!Watch[®] card.

Note: any cold chain failure can reduce vaccine effectiveness. If there has been a break in the cold chain, quarantine the vaccines in a refrigerator between +2 °C and +8 °C, marked “DO NOT USE”, until the pharmacist in charge makes a decision. Fill out the cold chain failure report ([Appendix 42](#)).

That report:

- describes the incident: location, date, circumstances, cause of problem, actions taken, name of person reporting.
- details:
 - the list of products with the manufacturer’s name, the lot number and the quantities;
 - the indications given by the temperature monitors (thermometer, VVM and Stop!Watch[®] card).

Quarantined vaccines may not be used until the person in charge gives authorisation after analysing the report.

6.6.2 Injection safety

Aseptic technique must be used at every step (vaccine reconstitution, syringe preparation and storage). See [Appendix 34](#).

Ask about any injection safety problems during previous campaigns.

To ensure injection safety:

- Use only auto-disable syringes with a fixed needle to administer the vaccine. These are single-use and impossible to reuse.
- Collect, transport, and dispose of waste in an appropriate manner.
- Follow the bundle policy for supply:

Orders and funding routinely include vaccines
+ auto-disable syringes + syringes for reconstitution
+ sharps collection and disposal containers (safety boxes).

- Educate all personnel on the risks of technical errors:
 - infection of personnel due to accidental needle stick;
 - local infection due to nonsterile injection (handling error during preparation or injection);
 - viral transmission (hepatitis B and C and HIV) due to reuse of injection supplies;
 - vaccine inefficacy due to reconstitution error or storage problem.
- Monitor best practices using the supervision grid ([Appendix 35](#)).

6.6.3 Surveillance of adverse events following immunisation (AEFI)

AEFI surveillance applies to everyone vaccinated against measles during the campaign that experiences one or more symptoms, appearing within 30 days of vaccination, that might be related to it.

AEFIs are detected by passive surveillance that begins the first day and ends 30 days after the campaign ends. Health care personnel are trained and definitions, tools and a reporting circuit are put in place.

Minor AEFIs (fever and injection site reactions), which do not endanger the person and do not require hospitalisation, are distinguished from serious AEFIs (e.g., anaphylactic reaction or encephalitis), which lead to hospitalisation, disability or death.

Health care personnel are trained to quickly detect and appropriately manage an anaphylactic reaction at the site. Each team is equipped with an ampoule of epinephrine (adrenaline), a 1 ml syringe and an intramuscular needle to administer the epinephrine ([Appendix 43](#)) before transferring the person to the hospital.

AEFIs must be reported ([Appendix 44](#) and [Appendix 45](#)). Serious AEFIs must be reported immediately for investigation and confirmation of the link to the vaccination.

Find out from the national immunisation programme how AEFIs are classified in the country. The WHO recommends the following classification:

- programme error: event caused by an error in vaccine preparation, handling, or administration;
- vaccine reaction: event caused or precipitated by the vaccine when given correctly, caused by the inherent properties of the vaccine;
- coincidental event: event that happens after immunisation but not caused by the vaccine;
- unknown: the event's cause cannot be determined.

6.6.4 Protection of personnel

There are a number of AEB-related risks:

- For vaccinators, the risk is high due to the large number of injections being administered at a sustained pace. To reduce the risks:
 - wear single-use gloves;
 - have the people accompanying the children help hold them.
- For logistics teams, accidents are due to incorrect use of safety boxes (filling them beyond the line, failing to close them completely), to waste sorting errors (needles thrown into rubbish bags, for example) or to unprotected transport of waste (not separate from people).

Wearing personal protective equipment is compulsory (this equipment is included in the vaccination kit):

- for waste collection: thick gloves (work gloves, at a minimum), coveralls with long sleeves and legs, and boots;
- for waste disposal: thick gloves, leather apron, safety glasses, coveralls with long sleeves and legs, boots and a mask.

All personnel should already know what to do in case of accidental exposure to blood (AEB) when the campaign begins.

A physician consultant is designated to:

- evaluate the risk for people who are exposed, decide whether to treat, and provide follow-up ([Appendix 46](#));
- fill out and/or centralise the AEB report forms ([Appendix 47](#));
- ensure that AEB kits are always available.

A bottle of 10% polyvidone iodine should be available at each vaccination site and waste storage/disposal area for topical treatment ([Appendix 46](#)).

6.7 Key points

- The preparation phase is crucial to ensuring a smooth operation.
- The timetable is a tool for visualising and coordinating all the activities that need to be put in place in a given time frame.
- Good coordination between medical and logistics teams is essential.
- Whenever possible, logistics and medical stocks should be kept in the same readily accessible location with round-the-clock electricity.
- The cold chain (storage, production, transport and monitoring) must be meticulously organised throughout the entire campaign.
- The number of sites and teams depends on the size and density of the population to be vaccinated, the expected output per team and the duration of the campaign.
- Team composition is standardised. All members must be trained and supervised.
- Kit- and module-based ordering simplifies needs estimation and supply management.
- Management tools are set up before the campaign starts, and personnel are trained to use them.
- Vaccination quality and safety must be ensured at all levels: high quality vaccines, cold chain, AEFI reporting, waste management and personnel protection.

Chapter 7: Activity monitoring and evaluation

[7.1 Objectives](#)

[7.2 Monitoring patient care](#)

[7.3 Monitoring vaccination](#)

[7.4 Intervention report](#)

[7.5 Evaluation of the response](#)

[7.6 Vaccine effectiveness](#)

[7.7 Key points](#)

7.1 Objectives

Activities are monitored to ensure that operations run smoothly, to measure the results and to identify any problems so that they can be resolved. Monitoring is done from the start of the outbreak to the end, either weekly (epidemiological surveillance and patient care) or daily (vaccination).

The information needed to calculate the indicators are routinely collected and analysed at the district level (vaccination coverage, vaccine utilisation rate, availability of treatments, etc.). The results of the analysis guide actions in the field.

7.2 Monitoring patient care

7.2.1 Number of cases and case fatality rate

The number of cases (uncomplicated and complicated) treated and the number of deaths in health facilities are reported each week via the epidemiological surveillance system.

The case fatality rate is calculated and monitored for each facility, making it possible to quickly identify places that need increased supply and/or supervision.

7.2.2 Treatment supply

The objective is to make sure that the number of treatments distributed is greater than the number of reported cases in all health care facilities throughout the outbreak.

Weekly monitoring ([Appendix 11](#)) of treatment availability is done by the team responsible for epidemiological surveillance. This “snapshot” is used to plan supply.

Data collection and monitoring methods are set up before – or as soon as – supply begins:

- Epidemiological data (number of cases and deaths per week) are obtained from epidemiological surveillance files.
- The number of treatments distributed is obtained from the donation forms ([Appendix 10](#)). These pre-filled forms are completed each time supplies are distributed. One copy stays in the treatment facility and the other is sent to the supply manager.
- These data can be summarized using the treatment availability monitoring table.

Weekly data analysis is used to:

- assess the pertinence and effectiveness of the strategy (decentralisation and coverage of all functioning treatment facilities);
- plan the distribution priorities each week based on the number treatments available, the epidemic curve and the case fatality rate;
- monitor consumption and plan a new order, if needed.

When the outbreak is over, compiling the data facilitates writing the final report and evaluating the responsiveness and pertinence of patient care.

7.3 Monitoring vaccination

Every evening the head of the vaccination team compiles the tally sheets and sends them to the supervisor. The supervisor checks the data and calculates the vaccination coverage and the vaccine utilisation rate. S/he shares the results with the teams. This feedback is important and motivates the teams.

If coverage is low, the supervisor looks for the reasons (ill-informed population, incorrect choice of site, vaccine shortage, lack of supplies, recording errors, etc.) and makes the necessary adjustments (plans extra vaccination days, changes the composition or number of the teams, changes the site, steps up or changes the public information, etc.).

At the end of the campaign, the campaign coordinator completes and analyses the summary table by site ([Appendix 27](#)), by district and the total. That table is used to:

- determine the overall vaccination coverage by age group and location;
- calculate all of the indicators at the end of the campaign;
- provide information to the Ministry of Health officials and partners;
- draft a final report.

7.3.1 Vaccination coverage

Definition

The vaccination coverage is the percentage of people immunised in the target population. Once calculated it shows whether the objective was met.

It is calculated for the entire target population and by age group and location.

$$\text{Vaccination coverage} = \frac{\text{Number of doses administered}}{\text{Target population}} \times 100$$

Estimation methods

- **Administrative vaccination coverage**

This is estimated during the campaign based on the data collected each day on the tally sheets and census data. This estimate has certain limitations related to:

- the reliability of the demographic data;
- errors in data collection (when recording) or calculation (when compiling);
- people being vaccinated from localities outside the target area.

- **Vaccination coverage survey**

A survey done at the end of the campaign yields more reliable numbers. It also provides information on activity quality:

- % of invalid doses (doses administered to people not belonging to the target population);
- reasons for non-vaccination;
- number of vaccine doses received;

- vaccination source (campaign or routine);
- percentage of children presenting a vaccination card.

The choice of survey type – cluster survey or lot quality assurance sampling – depends on the objectives and the resources available. While cluster surveys are simpler to do, their design does not allow identification of low coverage areas for planning catch-up vaccination.

7.3.2 Vaccine utilisation rate

Vaccine utilisation rate is a quality indicator. It is calculated by team, by day and by site based on the data collected on the tally sheets.

$$\text{Utilisation rate} = \frac{\text{Number of doses administered}}{\text{Number of doses used}^a} \times 100$$

An abnormal utilisation rate (less than 85% or more than 100%) should be checked immediately: the number of vaccine and diluent vials used and remaining, the calculations, the reconstitution conditions, problems with the team, etc.

Footnotes

(a) Number of vials opened multiplied by number of doses per vial.

7.4 Intervention report

When the intervention is over, write an accurate, concise and structured report. It should contain the following elements:

1. Context

- Measles situation in the country
- Demographic data for the affected population

2. Epidemiology

- Description of the surveillance system
- Description of the outbreak

3. Outbreak response

- Preparation
- Interaction/coordination with the different actors
- Initial evaluation/investigation
- Epidemiological surveillance
- Laboratory confirmation and surveillance
- Patient care
- Vaccination

4. Cost

5. Evaluation of the response

6. Recommendations

7. Appendices

- Map
- Detailed tables
- Graphs
- Protocols
- Information or documents of interest

7.5 Evaluation of the response

The evaluation can be exhaustive (analysis of each activity and strategies) or focus on certain activities and/or strategies.

It examines different aspects: effectiveness, accessibility, responsiveness, safety and quality, and resource mobilisation.

As soon as the intervention begins, define the objectives and indicators, make sure that the tools needed to collect the data are available and that the personnel are trained in using them.

Some indicators are collected routinely throughout the outbreak. Others are collected during field visits at a sample of health care facilities or vaccination sites, according to a specific methodology and with specific tools established at the start of the intervention. The information is compiled and analysed when the epidemic is over.

A final intervention evaluation report is written and presented to the epidemic management committee. It is a critical analysis of the operations conducted and offers recommendations for improving the next response. It is based on the evaluation tables below.

7.5.1 Evaluation of surveillance

Indicator	Data needed	Source/ collection tools	Method	Comments
Operational efficacy				
Percentage of facilities that have the case definition	<ul style="list-style-type: none"> Number of facilities where the case definition is available List of health care facilities by level 	<ul style="list-style-type: none"> List of health care facilities Case definition present in the facility Supervision/ observation grid 	Visit to a sample of health care facilities	Pay particular attention to peripheral facilities Expected result: 100%
Percentage of facilities that send weekly surveillance forms	<ul style="list-style-type: none"> Number of facilities that send the surveillance form each week Total number of health care facilities 	<ul style="list-style-type: none"> Weekly tracking form for reception of surveillance data List of health care facilities 	Exhaustive, for the duration of the outbreak	Expected result: 100%
Time to transmit weekly surveillance forms	<ul style="list-style-type: none"> Date weekly surveillance forms sent Transit time for surveillance data, in days 	<ul style="list-style-type: none"> List of health care facilities Weekly surveillance forms Weekly tracking form for reception of surveillance data 	Exhaustive, for the duration of the outbreak	Expected result: 1 week
Laboratory surveillance				
% positive samples	<ul style="list-style-type: none"> Number of samples taken by type of test requested Number of positive samples 	<ul style="list-style-type: none"> Laboratory test register Laboratory sample information form 	Exhaustive, for the duration of the outbreak, in sentinel districts	
	•	•	•	

Time to laboratory confirmation (time from identification of first cases to laboratory confirmation)	Date and location of first cases <ul style="list-style-type: none"> • Date of first positive results 	Weekly surveillance form <ul style="list-style-type: none"> • Laboratory register or laboratory sample information form 	Analysis of weekly surveillance forms or registers from health care facilities <ul style="list-style-type: none"> • Analysis of laboratory registers 	Expected result: 1 to 2 weeks max.
AEFI surveillance				
AEFI surveillance exists	<ul style="list-style-type: none"> • Existing surveillance system 	<ul style="list-style-type: none"> • District chief medical officer, person in charge of surveillance 	Interview	
Incidence of serious AEFIs	<ul style="list-style-type: none"> • Number of AEFIs by age group and location for the period • Number of people vaccinated during the campaign 	<ul style="list-style-type: none"> • Individual AEFI reporting form • AEFI summary table • Vaccination tally sheet or campaign activity reports 	<ul style="list-style-type: none"> • Exhaustive • Period: the duration of the vaccination campaign and for 30 days after the campaign ends 	
Breakdown of serious AEFIs by cause (programme error, vaccine reaction, coincidence, unknown)	<ul style="list-style-type: none"> • Total number of serious AEFIs by cause 	<ul style="list-style-type: none"> • Individual AEFI reporting form • AEFI summary table • List and classification of the causes of AEFI 	<ul style="list-style-type: none"> • Exhaustive • Period: the duration of the vaccination campaign and for 30 days after the campaign ends 	

7.5.2 Evaluation of patient care

Indicator	Data needed	Source/ collection tools	Method	Comments
Effectiveness				
Reported case fatality rate	<ul style="list-style-type: none"> Number of cases and deaths by administrative unit (region, district, etc.) By facility, by week and cumulative 	<ul style="list-style-type: none"> Measles surveillance Excel file 	Analysis of measles surveillance Excel file	Easily measured if the surveillance system is effective Expected result: < 5%
Overall CFR and specific CFR rate by age and by facility (hospital, outpatient clinic)	<ul style="list-style-type: none"> Number of cases and deaths recorded by age and by facility for the epidemic period 	<ul style="list-style-type: none"> Register of measles cases 	<ul style="list-style-type: none"> Calculated for each hospital Calculated for a random sample of outpatient clinics 	Eliminates bias due to an unreliable surveillance system Expected result: <ul style="list-style-type: none"> Outpatient: < 5% Hospital: < 15%
Accessibility				
Percentage of functional facilities that are supplied with treatments during the outbreak	<ul style="list-style-type: none"> Number of facilities supplied by administrative unit List and level of existing facilities by administrative unit 	<ul style="list-style-type: none"> Donation forms Stock cards Measles treatment availability Excel file 	Detailed analysis of donation forms and the list of health care facilities	Verify that all health care facilities are functional Expected result: 100%
Percentage of facilities that	<ul style="list-style-type: none"> Number of facilities 	<ul style="list-style-type: none"> Protocol present in the facility 	Visit to a sample of	Protocol in national

<p>have the treatment protocol</p>	<p>where the protocol is available</p> <ul style="list-style-type: none"> List and level of health care facilities 	<ul style="list-style-type: none"> Supervision/observation grid 	<p>health care facilities</p>	<p>language</p> <p>Expected result: 100%</p>
<p>Percentage of facilities that experienced a treatment shortage</p>	<ul style="list-style-type: none"> Inventory shortage noted at the district level: date and duration. Number of facilities that had a zero inventory List and level of health care facilities 	<ul style="list-style-type: none"> Stock cards Donation forms Measles treatment availability Excel file Supervision/observation grid 	<ul style="list-style-type: none"> Detailed analysis of stock cards, donation forms and measles treatment availability Excel file <p>or</p> <ul style="list-style-type: none"> Visit to a sample of facilities and verification of stock cards 	<p>Systematic analysis at the district level</p> <p>Expected result: no inventory shortage</p>
<p>Responsiveness</p>				
<p>Time to supply specific treatments (time from report of first cases to treatment supply)</p>	<ul style="list-style-type: none"> Date first cases reported Date specific treatments arrived at the facility 	<ul style="list-style-type: none"> Measles surveillance Excel file Stock cards Donation forms Measles treatment availability Excel file 	<p>Detailed analysis of the:</p> <ul style="list-style-type: none"> Measles surveillance Excel file Donation forms Stock cards Measles treatment availability Excel file 	<p>Pay particular attention to peripheral facilities</p> <p>Expected result: 1 to 2 weeks</p>

<p>Time from alert in the health zone to supply of specific treatments to district facilities (hospital, outpatient clinic)</p>	<ul style="list-style-type: none"> List of health care facilities supplied and date For each health zone: date of epidemic alert 	<ul style="list-style-type: none"> Measles surveillance Excel file Stock cards Donation forms Measles treatment availability Excel file 	<p>Detailed analysis of the:</p> <ul style="list-style-type: none"> Measles surveillance Excel file Donation forms Stock cards Measles treatment availability Excel file 	<p>Pay particular attention to peripheral facilities</p> <p>Expected result: 1 week</p>
--	--	---	--	--

Security/Quality

<p>Percentage of cases treated according to the recommended protocol</p>	<ul style="list-style-type: none"> Number of cases Number of cases treated according to the protocol Number of cases for which the protocol was not followed 	<ul style="list-style-type: none"> Recommended protocol Evaluation grid 	<p>On a sample of facilities, analysis of:</p> <ul style="list-style-type: none"> register of measles cases treatment forms or any other document indicating the treatment received 	<p>Pay particular attention to peripheral facilities</p> <p>Expected result: 100%</p>
---	---	---	---	--

<p>Injection safety</p>	<ul style="list-style-type: none"> Number of facilities using safety boxes Number of hospitals with an incinerator 	<ul style="list-style-type: none"> Evaluation grid 	<p>Visit to a sample of facilities and observation</p>	<p>Expected result: 100%</p>
--------------------------------	--	---	--	-------------------------------------

Cost

<p>Cost per patient</p>	<ul style="list-style-type: none"> Total cost of the curative 	<ul style="list-style-type: none"> Invoices Accounting documents 	<p>These costs include drugs,</p>	<p>Requires preparation</p>
--------------------------------	--	--	-----------------------------------	-----------------------------

treated	component of intervention <ul style="list-style-type: none">• Number of patients treated		supplies, transport and personnel	with the accounting staff
----------------	---	--	-----------------------------------	---------------------------

7.5.3 Evaluation of vaccination

Indicator	Data needed	Source/ collection tools	Method	Comments
Effectiveness				
Vaccine effectiveness	<ul style="list-style-type: none"> • Case definition • Total number of cases • Number of cases vaccinated and not vaccinated • Vaccination coverage 	<ul style="list-style-type: none"> • Register of measles cases or line listing • Vaccination card 	Several methods: <ul style="list-style-type: none"> • rapid evaluation • case-control or cohort study At one or several selected locations	Done by an epidemiologist (see Section 7.6) Expected result: > 80%
Number of cases prevented by vaccination Preventive fraction	<ul style="list-style-type: none"> • Demographic data • Total number of cases by week • Number of doses administered by location • Vaccination coverage by location • Dates of vaccination campaigns 	<ul style="list-style-type: none"> • Measles surveillance Excel file • Measles vaccination summary Excel file • District vaccination report • Results of vaccination coverage surveys • Team schedules 	<ul style="list-style-type: none"> • On a sample of locations • Separate calculation for rural and urban areas in the district 	Done by an epidemiologist
Accessibility				
Vaccination coverage by age group and location	<ul style="list-style-type: none"> • Number of doses administered: total, by age group and by location • Demographic data and target 	<ul style="list-style-type: none"> • Measles vaccination summary Excel file • Vaccination card (if survey) 	<ul style="list-style-type: none"> • Analysis of collected data • Vaccination coverage survey (on vaccination card or history) 	Expected result: <ul style="list-style-type: none"> • urban areas: 100% • rural areas: 80% (depending on objectives)

	population by age group and location			
Percentage of sites that did not experience a vaccine or ADS shortage	<ul style="list-style-type: none"> Date and duration of inventory shortages at the district level Number of districts that had an inventory shortage List of vaccination locations and sites 	<ul style="list-style-type: none"> Stock cards Donation forms Excel file for monitoring the supply of vaccine and supplies 	<ul style="list-style-type: none"> Analysis of documents or <ul style="list-style-type: none"> Visit to a sample of districts and vaccination sites and verification of the district's stock cards 	<p>At the end of the campaign:</p> <ul style="list-style-type: none"> Systematic analysis at the district level Pay particular attention to peripheral facilities <p>Expected result: 100%</p>
Responsiveness				
Time from the epidemic alert to the start and end of the vaccination campaign (when the outbreak is confirmed)	<ul style="list-style-type: none"> Date of the alert Date of the start and end of the campaign 	<ul style="list-style-type: none"> Measles surveillance Excel file Measles vaccination summary Excel file Intervention report 	<ul style="list-style-type: none"> Exhaustive if possible Calculation of time by location 	<p>Calculated at the end of the campaign</p> <p>Analyse urban and rural areas separately</p> <p>Expected result: 2 to 3 weeks (to start of the campaign)</p>
Number of people vaccinated per day and per team	<ul style="list-style-type: none"> Duration of the campaign: date by location (separate urban and rural areas) Number of doses administered by location Number of teams by day 	<ul style="list-style-type: none"> Tally sheet Measles vaccination summary Excel file Intervention report Vaccination team schedules 	<ul style="list-style-type: none"> Exhaustive if possible or <ul style="list-style-type: none"> Calculated for a random sample of locations 	<p>Analyse urban and rural areas separately</p> <p>Expected result:</p> <ul style="list-style-type: none"> urban areas: 1000/day rural areas: varies depending on the context

and by location

Security/Quality

<p>Vaccine utilisation rate</p>	<ul style="list-style-type: none"> • Number of doses injected • Number of doses used 	<ul style="list-style-type: none"> • Measles vaccination summary Excel file • Stock cards 	<p>Exhaustive for the entire length of the campaign</p>	<p>Expected result: $\geq 85\%$ (i.e., wastage $\leq 15\%$)</p>
<p>Ratio of ADS used/ number of safety boxes used</p>	<ul style="list-style-type: none"> • Number of ADS used • Number of safety boxes used 	<ul style="list-style-type: none"> • Measles vaccination summary Excel file • Stock cards • Team activity reports • Excel file for monitoring the supply of vaccine and supplies 	<ul style="list-style-type: none"> • Exhaustive or • On a random sample of sites 	<p>The ratio should not be greater than the maximum capacity of the safety boxes used</p> <p>Expected result:</p> <ul style="list-style-type: none"> • 5-litre box: 100 ADS • 15-litre box: 400 ADS
<p>Percentage of personnel suffering needlestick injury during the campaign (AEB)</p>	<ul style="list-style-type: none"> • Number of people suffering a needlestick injury during the campaign • Total number of personnel 	<ul style="list-style-type: none"> • AEB reporting form • Specific questionnaire 	<ul style="list-style-type: none"> • Exhaustive analysis (if AEB reporting in place) or • Random sample of personnel (use of a questionnaire) 	<p>If questionnaire used, verify that recommended AEB procedure was followed</p>
<p>Percentage of refrigerators with up-to-date temperature monitoring sheet</p>	<ul style="list-style-type: none"> • Number of refrigerators used for the campaign • Number of refrigerators with an up-to-date temperature 	<ul style="list-style-type: none"> • List of refrigerators used for vaccine storage • Temperature monitoring sheets 	<ul style="list-style-type: none"> • On a random sample of locations or • During supervision visits 	<ul style="list-style-type: none"> • At a minimum, monitor the district cold chain • To be monitored during the campaign <p>Expected result: 100%</p>

	monitoring sheet			
Percentage of vaccination sites with a proper waste collection and disposal system	<ul style="list-style-type: none"> Total number of sites Total number of sites having a proper waste collection and disposal system 	<ul style="list-style-type: none"> Observation grid 	<ul style="list-style-type: none"> Sample of sites Observation in the field 	<p>During the campaign</p> <p>Expected result: 100%</p>
Cost				
Overall cost of the campaign	<ul style="list-style-type: none"> Total expenditures 	<ul style="list-style-type: none"> Accounting of expenditures 	Analysis of expenditures: vaccines, injection supplies, transport, personnel, cold chain, logistics, etc.)	
Cost to vaccinate one person	<ul style="list-style-type: none"> Total amount of vaccination activities (urban/rural areas) Total number of doses administered (urban/rural areas) 	<ul style="list-style-type: none"> Measles vaccination summary Excel file Activity report Financial report: total expenditures for the vaccination campaign (urban/rural areas) 	Analysis of expenditures	Requires preparation with the accounting staff Analyse urban and rural areas separately
Cost per case and death prevented	<ul style="list-style-type: none"> Total amount of vaccination activities Number of doses administered 	<ul style="list-style-type: none"> Measles surveillance Excel file Measles vaccination 	Analysis of expenditures	After the campaign

	<ul style="list-style-type: none"> Calculation of cases prevented 	<ul style="list-style-type: none"> summary Excel file Intervention report 		
Resources				
Ratio of ADS used/ number of vaccines administered	<ul style="list-style-type: none"> Number of ADS used Number of people vaccinated 	<ul style="list-style-type: none"> Measles vaccination summary Excel file Stock cards Team activity reports 	<ul style="list-style-type: none"> Overall in the district On a random sample of sites 	Expected result: the ratio should not be less than 1
Percentage of teams with an appropriate number of people	<ul style="list-style-type: none"> Number of people per team and appropriate qualifications for task 	<ul style="list-style-type: none"> Observation grid 	<ul style="list-style-type: none"> On a random sample of sites or During supervision visits 	<ul style="list-style-type: none"> Standard team composition defined at the start of the campaign (urban and rural) During the campaign <p>Expected result: 100%</p>

7.5.4 Evaluation of social mobilisation

Indicator	Data needed	Source/ collection tools	Method	Comments
Efficiency/Operational efficacy				
Percentage of reasons for non-vaccination related to lack of information	<ul style="list-style-type: none"> Total number of unvaccinated persons Reason for non-vaccination 	Vaccination coverage survey with study of reasons for non-vaccination	Vaccination coverage survey	<p>Done at the end of the campaign</p> <p>Expected result: < 10%</p>

7.6 Vaccine effectiveness

7.6.1 Definitions

Serological protection (efficacy) has to be distinguished from that obtained when using the vaccine under real conditions (effectiveness):

- Efficacy, which is measured under randomised clinical trial conditions, means that the vaccine has demonstrated its immunogenicity, that is, its ability to protect.
- Vaccine effectiveness means that the vaccine has demonstrated its ability to protect under real-life conditions. It reflects the clinical efficacy of the vaccine, the characteristics of the individual vaccinated (age and immune status) and programme errors (cold chain and vaccine preparation and administration technique).

7.6.2 When to calculate vaccine effectiveness?

The effectiveness of the vaccine under real conditions is calculated in the following situations:

- when an outbreak occurs in a correctly-vaccinated population (very high vaccination coverage);
- when there is no reduction in measles incidence despite high vaccination coverage;
- when there are a significant percentage of vaccinated people among measles cases;
- when a new vaccine is introduced.

7.6.3 Principle

The percentage reduction in the attack rate is calculated for those vaccinated versus those not vaccinated. This yields the preventive fraction in the vaccinated group. The formula is:

$$VE \text{ (in \%)} = \frac{NVAR - VAR}{NVAR}$$

VE	Vaccine effectiveness
NVAR	Attack rate among the unvaccinated
VAR	Attack rate among the vaccinated

The study should be done quickly (ideally in about ten days).

7.6.4 Validity

The reliability of effectiveness studies and the validity of the results depend on several factors:

- The case definition should be standardised and applied uniformly.

- The search for and identification of cases should be identical and as exhaustive as possible for the population being studied.
- Determination of vaccination status must be rigorous for both patients and non-patients. Ideally, the vaccination status is established by presentation of a card indicating the vaccination date.
- The risk of exposure to the disease should be comparable in the two groups (vaccinated and unvaccinated).
- The vaccination coverage data should be as reliable as possible.

7.6.5 Study sample

The sample should be representative of measles cases as a whole; study a group of patients from facilities at all levels (outpatient clinics and hospitals).

The sample will depend on the type of programme being evaluated:

Programme	Inclusion period
Routine immunisation programme (children vaccinated by the EPI prior to the vaccination campaign)	Include only measles cases that occurred before the vaccination campaign.
Outbreak response vaccination campaign	Include only measles cases that occurred more than two weeks after the campaign
Comprehensive, all strategies combined (EPI, SIA, outbreak response)	Include all measles cases.

Inclusion criteria

- Suspected case of measles (case definition)
- Measles case belonging to the age group being studied
- Measles case reported in the defined geographic area
- Measles case whose vaccination status is known (card presented)

Exclusion criteria

- Uncertainty about the diagnosis
- Age not known
- Measles case living outside the defined geographic area
- Measles case whose vaccination status is not known (no card)

7.6.6 Measurement methods

Three methods are currently used: the rapid estimation method, cohort studies and casecontrol studies. The last two require a specialised epidemiology team.

Rapid estimation method

This is the easiest first-line method for identifying a problem with vaccine effectiveness and deciding whether to do a more in-depth evaluation.

If possible, use vaccination coverage data from surveys for the calculation. Otherwise, use the estimated vaccination coverage (administrative).

The effectiveness is estimated based on the percentage of the population vaccinated (measles vaccination coverage) and the percentage of vaccinated among the measles cases:

$$VE \text{ (en \%)} = \frac{PPV - PCV}{PPV \times (1 - PCV)}$$

VE	Vaccine effectiveness
PCV	Percentage of cases vaccinated
PPV	Percentage of the population vaccinated

The curves generated by this equation (nomogram) allow rapid evaluation of vaccine effectiveness.

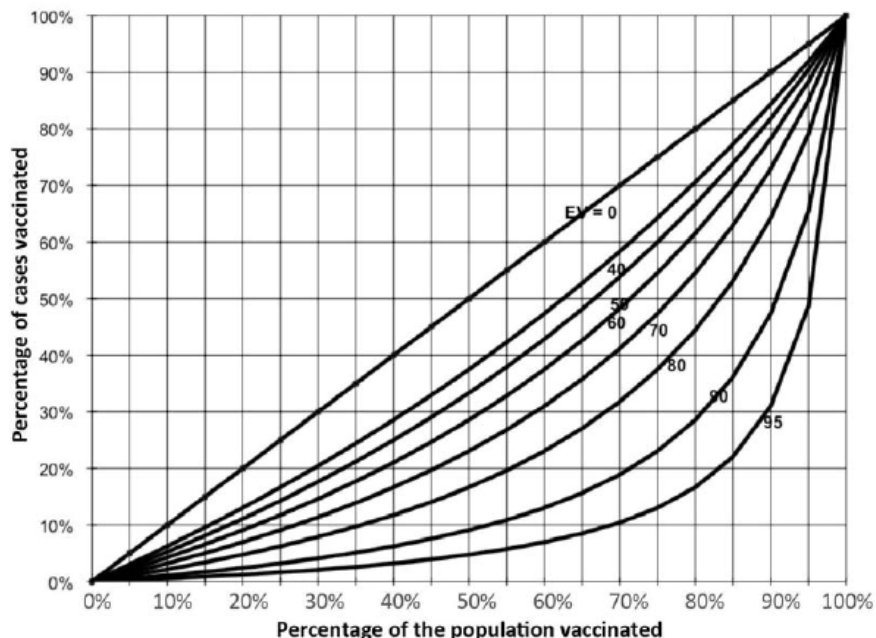

If the result is $\geq 80\%$, one can assume that there is no vaccine effectiveness problem.

If, on the other hand, the calculated vaccine effectiveness is $< 80\%$, evaluation with a more accurate method (cohort or case-control study) is needed.

Note, however, that when coverage is low this method yields a biased estimate of vaccine effectiveness.

Example: a vaccination campaign was conducted 9 months ago. An vaccination coverage survey showed that 85% of the target population was vaccinated (PPV = 85%). Some measles cases have been reported; half of them were vaccinated during the campaign (PCV = 50%).

$$EV = [0.85 - 0.50] / 0.8 \times (1 - 0.5) = [0.35] / (0.425) = 82\%$$

Drawing a straight vertical line from 85% on the x-axis and a straight horizontal line from 50% on the y-axis, the two lines intersect in the vaccine effectiveness region between the 0.8 and the 0.9 curves, consistent with the value obtained by calculation.

Cohort study

This complex method allows comparison of the attack rates among the vaccinated (VAR) and the unvaccinated (NVAR) and calculation of the relative risk, that is, the difference in the risk of developing the disease when vaccinated. The formula is as follows:

$$\text{Relative risk} = \frac{\text{VAR}}{\text{NVAR}}$$

or

$$VE (\%) = (1 - \text{relative risk}) \times 100$$

Example:

Measles attack rate among the vaccinated (VAR) = 1%

Measles attack rate among the unvaccinated (NVAR) = 7%

Relative risk = 0.01/0.07 = 0.14 or VE = 1 - 0.14 = 86%

Case-control study

This study compares the vaccination status of a sample of cases and controls. It does not study the at-risk population. The cases represent a sampling fraction of all measles cases, and the controls represent a sampling fraction of the population that did not get the disease. For each case, at least one matched control (in terms of age, gender, place of residence, initial health status, etc.) is chosen at random.

Knowing the vaccination status of the cases and controls allows estimation of the relative risk (comparing the attack rate for the vaccinated to the attack rate for the unvaccinated) by measuring the odds ratio (OR).

Thus:

	Cases	Controls	
Vaccinated	a	b	OR = ad / bc and VE = 1 - OR
Unvaccinated	c	d	

Example: Of the 49 cases selected, 8 were vaccinated and 41 were not.

Of the 50 controls, 32 were vaccinated and 18 were not.

Thus:

	Cases	Controls	
Vaccinated	8	32	OR = (8 x 18)/(41 x 32) = 0.11 and VE = 89%
NUnvaccinated	41	18	

7.7 Key points

- Treatment and immunisation activities are monitored from the start to the end of the outbreak.
- Monitoring treatment availability on a weekly basis permits distribution strategy planning; the number of treatments distributed should be greater than the number of reported cases, and the case fatality rate should be acceptable.
- The vaccination coverage indicator is essential to evaluating the effectiveness of the immunisation strategy.
- The vaccine utilisation rate is an indicator of the quality of the vaccination teams' work.
- The intervention report should be accurate, concise and structured.
- An evaluation of the outbreak response allows a critical look at a number of aspects (effectiveness, accessibility, responsiveness, safety, quality and resource mobilisation) and recommendations for improving future interventions.
- Vaccine effectiveness can be measured if there is doubt about the impact of vaccination.

Chapter 8: Outbreak preparedness

[8.1 Preparedness and response plan](#)

[8.2 Activities to implement](#)

8.1 Preparedness and response plan

The outbreak preparedness plan is designed by the Ministry of Health. It is updated each year before the epidemic season.

It analyses the epidemiological situation in the country for measles (cases, deaths, EPI and campaign vaccination coverage) and identifies the zones at risk for an outbreak.

Based on activity/assessment reports, it presents a summary of previous outbreaks (constraints, strategies, results, and lessons learned).

It establishes the outbreak definition criteria.

It defines the response strategies (surveillance, patient management, vaccination, public information, etc.).

It specifies the decision-making mechanisms and responsibilities at each level.

8.2 Activities to implement

8.2.1 Epidemiological surveillance

The surveillance system for measles cases should be reinforced at the national, regional and local level.

All means necessary for surveillance (standardised case definition and standardised data collection forms) should be available at all levels.

Health staff should be informed about the risk of an outbreak so they can quickly identify the first cases.

8.2.2 Laboratory surveillance

All means necessary for performing laboratory tests on the first suspected cases (sample collection equipment, information form for laboratory diagnosis of measles, laboratory contact information, etc.) should be available at the regional and local level.

8.2.3 Patient management

The information needed for quickly setting up care should be assembled and updated:

- population census;
- geographic map and access (distance and road conditions);
- health system and personnel (including those with vaccination experience);
- availability of drugs and supplies;
- available means of transportation;
- list of actors and partners.

Treatment kits should be pre-positioned at the regional and local level in order to treat patients in the first few weeks of the outbreak. Stocks are estimated based on the epidemiological data from previous years (at-risk areas, population).

Treatment protocols should be available at all health care facilities.

8.2.4 Vaccination

In addition to the information above, the information needed for quickly organising a vaccination campaign should be assembled and updated:

- availability of vaccines and injection supplies;
- inventory of cold chain equipment;
- existing vaccination guidelines (national and other).

8.2.5 Public information and sensitization activities

Messages should be prepared and information channels ready to disseminate the information.

8.2.6 Outbreak management committees

The committees are reactivated at the national, regional and local level to coordinate the preparation for and response to the outbreak.

8.2.7 Budget

A budget should be drawn up in order to obtain the funding needed for operations.

Appendices

[Appendix 1. Examples of epidemics and vaccination responses](#)

[Appendix 2. Register of measles samples](#)

[Appendix 3. Request form for laboratory diagnosis of measles](#)

[Appendix 4. Laboratory tests](#)

[Appendix 5. Register of measles cases](#)

[Appendix 6. Measles surveillance](#)

[Appendix 7. Standard distribution of population in developing countries](#)

[Appendix 8. Measles inpatient unit organization \(example\)](#)

[Appendix 9. Estimating needs - Measles treatments](#)

[Appendix 10. Donation form - examples](#)

[Appendix 11. Treatment availability monitoring](#)

[Appendix 12. Example of public information message](#)

[Appendix 13. Case management](#)

[Appendix 14. Plan rehydration WHO](#)

[Appendix 15. Clearing of the nasopharynx \(nasal irrigation\)](#)

[Appendix 16. Epinephrine nebulization](#)

[Appendix 17. Example of vaccination campaign timetable](#)

[Appendix 18. Estimating needs - Vaccines and injection supplies](#)

[Appendix 19. Cold chain equipment](#)

[Appendix 20. Cold chain evaluation/inventory](#)

[Appendix 21. Cold chain equipment technical sheets](#)

[Appendix 22. Temperature monitoring form](#)

[Appendix 23. Estimating needs - Freezing capacity for a vaccination campaign](#)

[Appendix 24. Immunization kit, 10,000 vaccinations/ 5 teams \(KMEDKIMM3--\)](#)

[Appendix 25. Measles vaccination cards \(examples\)](#)

[Appendix 26. Tally sheet for vaccinations and vaccine monitoring](#)

[Appendix 27. Measles vaccination summary](#)

[Appendix 28. Calculating the number of teams needed for vaccination](#)

[Appendix 29. Vaccination team member roles](#)

[Appendix 30. Job description, campaign medical supervisor](#)

[Appendix 31. Job description, campaign logistics supervisor](#)

[Appendix 32. Stock card](#)

[Appendix 33. Delivery form for vaccines and vaccination supplies](#)

[Appendix 34. Vaccine preparation and storage during mass vaccination campaigns](#)

[Appendix 35. Vaccination team observation/ supervision grid](#)

[Appendix 36. Vaccination site organisation](#)

[Appendix 37. Module equipment for one vaccination team](#)

[Appendix 38. Module equipment for one supervision team](#)

[Appendix 39. Monitoring distribution and consumption of vaccines and medical supplies](#)

[Appendix 40. Vehicle and fuel monitoring](#)

[Appendix 41. Cold chain monitoring tools](#)

[Appendix 42. Cold chain failure report](#)

[Appendix 43. Severe allergic reaction to a vaccine](#)

[Appendix 44. Individual notification form for AEFI with measles vaccine](#)

[Appendix 45. Summary table of AEFI with measles vaccine](#)

[Appendix 46. Accidental exposure to blood \(AEB\) during a vaccination campaign](#)

[Appendix 47. Reporting form for AEB during a vaccination campaign](#)

Appendix 1. Examples of epidemics and vaccination responses

Maroua, Cameroon, 2008-2009^[1]

The city of Maroua has an estimated population of 273,170.

The curve shows:

- an increase in the number of cases in May 2008 (39 cumulative cases);
- another increase in October 2008 in certain neighbourhoods, coinciding with an influx of refugees. A vaccination campaign targeting children ages 9 months to 5 years was conducted in these areas;
- despite that intervention, the number of measles cases continued to rise, with a peak in late January 2009.

A total of 875 cases and 8 deaths were reported between 1 January 2008 and 6 April 2009. The epidemic lasted seventeen weeks.

Number of measles cases, Maroua, Cameroon, 2008-2009

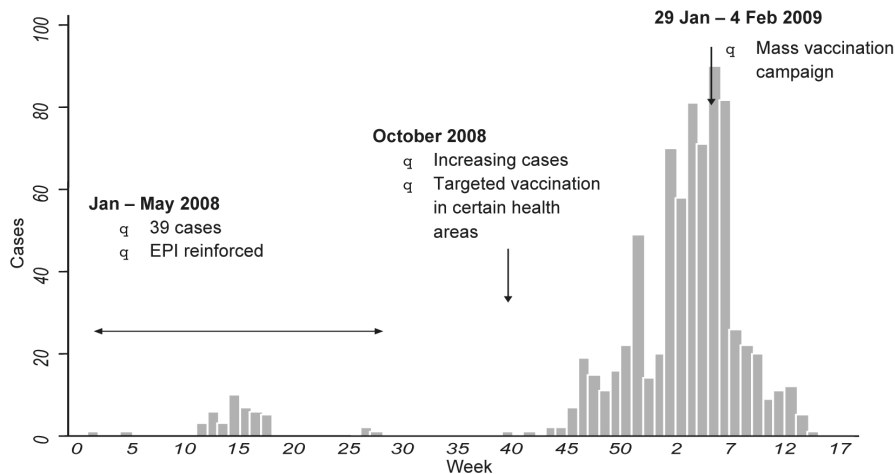

Several actions were taken:

- early 2008: routine vaccination (EPI 9-11 months) reinforced in the health centres in the affected areas;
- october 2008: selective vaccination of children ages 9-59 months (unvaccinated) in certain affected areas;
- late January 2009, given the continuing increase in measles cases: non-targeted mass vaccination campaign for children ages 9 months to 15 years, thirteen weeks after the outbreak started.

A vaccination coverage (VC) survey was used to evaluate the coverage achieved by the successive approaches:

- 74.1% (95% CI: 70.0%-78.3%) of children were vaccinated by the routine EPI, with low coverage among children ages 9 to 24 months (66%);
- 28.1% (95% CI: 22.3%-33.9%) during targeted vaccination campaigns in October 2008;

- 79.7% (95% CI: 76.4%-82.9%) during the non-targeted campaign in January 2009.

After these interventions, the estimated VC was over 90% in children ages 9 months to 15 years.

6.1% of children were still unvaccinated after these interventions. The main reasons for a child not receiving routine vaccination were refusal (25%) and lack of information (22%). For the targeted vaccination and the non-targeted campaign, the primary reason was the lack of information (37%).

The EPI's inadequate vaccination coverage allowed a recrudescence of cases in some neighbourhoods.

Reinforcing vaccination activities did not prevent an outbreak.

The vaccination campaign conducted a few weeks after the start of the outbreak helped control its spread (decline in incidence two weeks after the campaign ended). The outbreak ended in Week 14.

N'Djamena, Chad, 2010

The city of N'Djamena has an estimated population of 1,133,794.

The last measles outbreak occurred in 2005, with 8,015 reported cases (attack rate = 660/100,000). A vaccination campaign targeting children ages 6 months to 5 years was conducted 2006.

The curve shows that:

- From 2007 to 2009, there were few reported cases and the routine vaccination coverage (VC) dropped year by year.
- In 2008, a vaccination campaign (SIA) was conducted in all districts. The overall VC was an estimated 68% (90%, 71%, 68% and 63% in the northern, southern, central and eastern districts, respectively).
- In early 2010 there was an increase in the number of cases: 689 cases from Week 1 to 7, with an attack rate that was four times higher than in previous years. There were significant disparities between districts; the attack rate in the eastern district was 6.3 times higher than in the northern district, 1.8 times higher than in the southern district, and 1.5 times higher than in the central district.
- In Week 7, an investigation was conducted and EPI vaccination reinforced.
- Despite that intervention, the number of cases increased, reaching a peak in Week 12.

A total of 8,733 cases and 32 deaths were reported from Week 1 to Week 25. The outbreak lasted sixteen weeks.

Number of measles cases per week. N'Djamena, Chad. 2007 to 2010

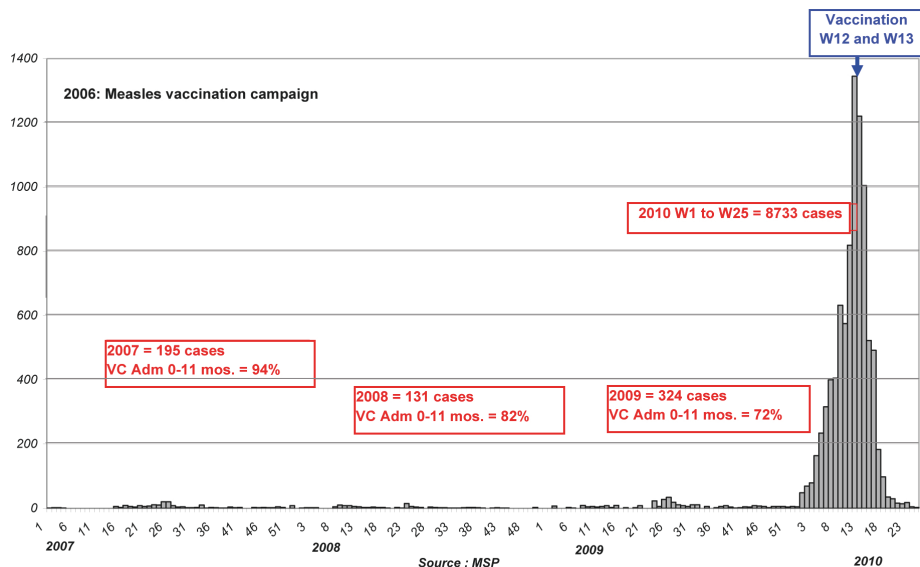

Several actions were taken in response to this outbreak:

- beginning at Week 7: reinforcement of EPI (9-11 months);
- from Week 12 (10 weeks after the start of the outbreak) to Week 15, non-targeted mass vaccination campaign for children ages 6 months to 15 years.

A vaccination coverage survey assessed the VCs before and after the mass vaccination campaign:

- before the campaign, overall VC for children ages 6 months to 15 years: 70.4% (95% CI: 68.5%-72.3%);
- after the campaign, overall VC for children ages 6 months to 15 years: 82.5% (95% CI: 81.5%-83.5%).

The main reasons for non-vaccination were: practical reasons (37%), vaccination refusal (25%), lack of information (14%), previous vaccination (1%), and no explanation (16%).

The VC (EPI + 2008 mass vaccination campaign) was inadequate and allowed a recrudescence of cases in early 2010 (even larger in neighbourhoods where vaccination coverage was lowest).

Reinforcing EPI activities did not prevent an epidemic.

The belated outbreak response vaccination (10 weeks after the epidemic started) helped control its spread (incidence fell in the weeks that followed), and the outbreak ended around Week 22.

References

1. Luquero FJ, Pham-Orsetti H, Cummings DA, Ngaunji PE, Nimpa M, Fermon F, Ngoe N, Sosler S, Strebel P, Grais RF. *A long-lasting measles epidemic in Maroua, Cameroon 2008- 2009: mass vaccination as response to the epidemic.* J Infect Dis. 2011 Jul;204 Suppl 1:S243-51. doi: 10.1093/infdis/jir093.

Appendix 3. Request form for laboratory diagnosis of measles

Requested by	
Country	
Region	
Town	
Health care facility	
Prescribing doctor	
Contact info (tel, e-mail)	

Specimen (check the appropriate box)	
Date:	
Blood on filter paper <input type="checkbox"/>	Oral fluid <input type="checkbox"/> Whole blood <input type="checkbox"/> Serum <input type="checkbox"/>

Patient	
Last name or ID number	
First name	
Age (months or years)	
Sex	
Address	

History of the illness	
Date of last dose of measles vaccine	
Number of doses received (specify card or history)	
Date of onset of fever	
Date of onset of rash	
Diagnosis	
Consultation or admission date	

Context (check the appropriate box)	
Beginning of outbreak <input type="checkbox"/>	Ongoing outbreak <input type="checkbox"/> End of outbreak <input type="checkbox"/>

Transport	
Date sent	
Date received	
Transport conditions	

Comments

Photocopy the form, complete and attach to sample.

See [Toolbox](#)

Appendix 4. Laboratory tests

Laboratory confirmation is based on testing for specific antibodies to the measles virus (ELISA detection of IgM antibodies).

Tests based on virus detection (nested RT-PCR) are used not for diagnosing cases but for studying the genome (global measles surveillance) or for isolating the virus.

The specimen collection techniques are the same regardless of test type.

4.1 Specimen collection

Before taking the sample	<ul style="list-style-type: none">• Prepare the equipment: gloves, gown, antiseptic, cotton wool or compresses, indelible marker; plastic safety box, etc.• Fill out the information form and lab test register (see Appendix 3).• Wash hands or disinfect them with an alcohol-based solution, and don gloves.
After taking the sample	<ul style="list-style-type: none">• Sort/discard waste: needles and lancets in a safety box, contaminated material (tongue depressors, cotton wool, etc.) in a trash bin.• Verify the identity of the patient (tube, filter paper, request form, register).

4.1.1 Collecting capillary blood on filter paper

Equipment

- Filter paper (Whatman 903®: card with four 15-mm diameter circles for receiving the specimen)
- Plastic 10 x 10-cm zip lock bag (bag for medications)
- Sterile lancet
- Silica gel packet

Technique

- Label the filter paper card with the patient's last name, first name and age, and the location and date of specimen collection.
- Disinfect the finger, allow it to air dry, and prick with the lancet.
- Wipe away the first drop of blood with a compress or cotton wool.
- Collect the blood on the filter paper. Completely saturate the circles on the card. Check to make sure that the paper is saturated on both sides.
- Let the filter paper air dry, away from sunlight and dust, for 2 hours.
- Once it is dry, place the filter paper in the plastic bag, add the silica gel packet, and close.

4.1.2 Collecting oral fluid

Equipment

- Tongue depressor
- Oral specimen collection device (ORACOL® or OraSure®): sponge, shaft, and tube with cap
- Scissors (depending on the device used)

Technique

- Label the tube with the patient's last name, first name and age, and the location and date of specimen collection.
- Gently rub the sponge, attached to the shaft, along the gum-tooth junction for about 1 minute. The sponge absorbs about 0.5 ml of crevicular fluid.
- Place the whole device (sponge + shaft) in the tube. Follow the manufacturer's recommendations.
- Close the tube.

4.1.3 Collecting venous blood and preparing serum

Equipment

- Plain (serum) vacuum tube + tube holder (or if not available, a simple plain tube)
- 21G or 23G needle
- Sterile transfer pipette
- Sterile 2-ml cryotube
- UN 3373 isothermal triple packaging container

Technique

- Label the plain tube and the cryotube with the patient's last name, first name and age, and the location and date of specimen collection.
- Disinfect the puncture site.
- Draw 5 ml of blood in the serum tube.
- If shipping time is less than 24 hours, no preparation is needed; send the whole blood to the laboratory.
- If the shipping time is over 24 hours:
 - Centrifuge the blood for 10 minutes at 3000 rpm (1000 g) to obtain serum. If there is no centrifuge, leave the tube in an upright position for one hour at ambient temperature so that the clot retracts, and then refrigerate it until contents are completely separated (serum yellow and clear).
 - Draw off the serum with a sterile pipette and transfer it to the sterile cryotube.

4.2 Storing samples

	Storage time	Storage temperature	Comments
Capillary blood	≤ 7 days	Room temp. (< 42 °C)	
	> 7 days	4 to 8 °C	
Oral fluid	≤ 7 days	Room temp. (< 42 °C)	
	> 7 days	Depends on device ^(a)	Use another specimen type, if possible
Whole blood	< 24 hours	4 to 8 °C	
Serum	< 7 days	4 to 8 °C	
	> 7 days	– 20 °C	No successive freezing/thawing

(a) The OraSure® device (with transport medium) allows ambient temperature (< 39 °C) transport for up to 21 days.

4.3 Transport, packaging, and shipping

Blood on filter paper and oral swab

These specimens are not considered pathogenic: no triple packaging. However, they must be placed in a waterproof bag (a plastic zip lock bag, for example).

Whole blood or serum

Protect each tube in specific triple packaging that meets the regulations for transporting Category B infectious substances, UN 3733.

Before shipping

Verify that:

- the containers are tightly sealed;
- the information is entered in the laboratory register;
- the patient information form is inside the package.

When shipping

- Write the exact address (including the service and the name of the addressee).
- For whole blood or serum: fill out the information on the outer container (3373).
- Attach all necessary shipping documents.
- Record the shipment to allow follow-up (receipt at lab and transmission of results).

- Alert the services concerned that the sample(s) have been shipped.

4.4 Reference laboratories

Send specimens to national laboratories, if possible; if not, use the closest WHO LabNet laboratory.

Appendix 5. Register of measles cases

Region:		District:									
Health facility/Hospital:											
Admission date	Patient's name	Residence address (health zone, town, village)	Age	Sex	Treatment ^a	Outcome ^b			Vaccination		
						R	D	T	YES		NO
									Card ^c	History ^d	

^a Treatment prescribed: INN, dosage, duration.
^b Outcome: R = recovery, D = death, T = transfer.
^c Enter the vaccination date written on the vaccination card.
^d History: the patient does not have a card, but he (or his family) is certain that he was immunised against measles.

See [Toolbox](#)

Appendix 6. Measles surveillance

The Excel file **MEASLES SURVEILLANCE** (see [Toolbox](#)) contains several worksheets, some of them protected, which automatically generate epidemic curves from the data entered.

The file allows summarizing the weekly data for each district and health care facility, in order to detect an outbreak and monitor its progress.

Using the worksheets

- Use one file for each region. Each file includes:
 - an automatic summary worksheet for the region;
 - an “Epidemic curve for the region” worksheet;
 - a “Weekly incidence per district” worksheet;
 - fifteen “District” worksheets named from A to O. Do not create new worksheets;
 - fifteen “Epidemic curve” worksheets for each of the districts A through O.
- Fill in only the yellow boxes. Do not enter data into other boxes as this may modify the automatic calculations and generate errors.
- When doing the weekly update to the file, change the week number in the file name.

“District” worksheets

- When using for the first time:
 - Begin with the “District A” worksheet.
 - Enter the name of the region and district, and the year.
 - Enter the week number when monitoring began. Subsequent week numbers will display automatically for all of the districts and for the region.
 - For each facility, enter its name and the population served. The total population of the district is calculated automatically.
 - Enter the name of the district on the tab.
- Each week:
 - Enter the number of cases and deaths per facility. Note that if there are no cases, enter “zero” cases. Do not write “zero” cases if there is no data.
 - The totals are calculated automatically for each facility and for the district.
 - The case fatality rate and the incidence are calculated automatically.
 - If the number of cases doubles for two consecutive weeks or the CFR is over 5%, the corresponding cells display in red.

“Epidemic curve per district” worksheets

An epidemic curve is automatically created for each district (A through O).

When using for the first time, enter:

- the name of the district, the name of the region, the country and the year;

- the source of the information;
- the number of inhabitants;
- the name of the district on the tab.

Note that these graphs are created with an automatic scale. To compare curves for different districts, make sure that the scale is the same; change if necessary.

“Region” worksheet

When using for the first time, enter the name of the region on the tab.

This worksheet is completely protected and generated automatically from the sheets for each district.

“Epidemic curve region” worksheet

This curve is created automatically.

When using for the first time, enter:

- the name of the region, the country and the year;
- the source of the information;
- the number of inhabitants;
- the name of the region on the tab.

“Weekly incidence per district” worksheet

These curves are created automatically.

When using for the first time, enter:

- the name of the country and the year;
- the source of the information.

Appendix 7. Standard distribution of population in developing countries

Shown as % of the total population

Children under 5 years of age	
0 - 11 months	4%
12 - 23 months	3%
24 - 35 months	3%
36 - 47 months	3%
48 - 59 months	3%
Total	16%

Total population		
0 - 4 years	16%	= 70%
5 - 14 years	27%	
15 - 29 years	27%	
30 - 44 years	16%	
≥ 45 years	14%	
Total	100%	

Example: if the target population is the population aged 2-30 years, the target population represents 63% of the total population.

By gender	
Total females	49.5%
Total males	50.5%
Females 15 to 44 years	25.5%
Pregnant women	4%

Notes:

- This distribution varies depending on the country and the context.
- Always use national figures if available.

Appendix 8. Measles inpatient unit organization (example)

See [Toolbox](#)

8.1 General organization

Capacity

- 40 to 50 beds:
- 10 intensive care beds
- 30 to 40 inpatient beds

Staff

Doctors	3	1 per day, 1 per night, 1 off
Supervisor	1	6 days a week
Nurses	9	3 per day, 3 per night, 3 off
Nurse's aides	6	2 per day, 2 per night, 2 off
Hospital cleaners	4	2 per day, 2 off
Watchmen	6	2 per day, 2 per night, 2 off

Shift schedule

6 am-6 pm (12 hrs.); 6 pm-6 am (12 hrs.); supervisor: 8:30 am-1 pm/ 3 pm-5:30 pm

Schedule for monitoring vital signs and administering treatments (oral and parenteral)

Frequency	Suggested schedule
Once daily	7 am
2 times daily	7 am / 7 pm
3 times daily	7 am / 1 pm / 8 pm
4 times daily	7 am / 1 pm / 8 pm / 2 am
Every hour	In intensive care, according to doctor's orders

8.2 Documentation

Register of admissions/discharges	Admissions	Completed by the supervisor or the nurse.
Patient's file	At patient's bedside	Completed by the doctor. Nurses and nurse's aides enter the monitoring data and orders carried out.
Hourly monitoring sheet	At patient's bedside	Completed by the nurse and nurse's aide, at doctor request.
Monitoring record of consumption (drugs and medical supplies)	Unit	Completed by the supervisor every week.
Handover book	Ward	Completed by the nurse and the nurse's aide.
Patient board	Ward	Updated by the supervisor.

8.3 Staff duties

Doctor

- Performs daily rounds with the supervisor and a nurse.
- Notes the prescriptions and procedures to be carried out.

- Makes admission and discharge decisions; handles emergencies.
- Does handovers to the on-call doctor, nurses and supervisor.
- Updates the records (including the patient's health record at discharge).
- Manages patient discharges: patient information, treatments, discharge authorization.
- Helps supervise and train health staff.

Supervisor

- Makes sure that the unit runs correctly: quality of care; supply (drug and supply orders and consumption); hygiene; and meal distribution.
- Makes sure that documents are used correctly: handover book, monitoring records, etc.
- Accompanies the doctor on his or her rounds.
- Sets up the staff schedules and makes sure the personnel are present.
- Checks and records daily the number of patients, admissions, discharges, and deaths.
- Supervises and trains the staff; writes job descriptions; organises and leads the unit's meetings (once weekly).
- Collects weekly data and archives the records of discharged patients.
- Reports any problems to the person in charge.

Nurse

- Administers treatments, performs laboratory exams, etc. and monitors the patients.
- Informs the doctor of any problems found.
- Notes the prescriptions and procedures carried out.
- Participates with the doctor in rounds.
- Prepares and keeps carts organized (rounds and treatment).
- Briefs team at change-of-shift and updates the handover book.

Nurse's aide

- Gets the patient settled and gives him the necessary supplies (blanket, eating utensils, etc.).
- Explains the organisation of the service to the patient and the person accompanying him (meal schedule, visiting hours, location of bathrooms).
- Helps the patient with taking medications, eating, and personal hygiene, if necessary; reports all useful information to the nurse.
- Assists the nurse with certain care procedures.

Hospital cleaner

- Cleans the premises, both inside and outside.

Appendix 9. Estimating needs - Measles treatments

The Excel file **ESTIMATING NEEDS - TREATMENT** for measles cases (see [Toolbox](#)) contains several worksheets, some of them protected.

This file automatically calculates the needs (according to the standard protocol) based on the epidemiological data entered. It facilitates ordering and drawing up a projected budget.

The first order should cover treatment needs for a reasonable period, taking into account order/delivery times (e.g., 4 to 8 weeks). Subsequent orders will depend on the progress of the outbreak and the needs.

Using the worksheets

- The file includes:
 - a worksheet indicating the content of the treatment kits;
 - four “Estimating measles treatment needs” worksheets (as well as a sample worksheet). Use one worksheet per order. If necessary, create new worksheets for subsequent orders.
- Fill in only the yellow boxes. Do not enter data into other boxes as this may modify the automatic calculations and generate errors.

“Estimating needs” worksheet

- For each order, enter:
 - the expected attack rate for the epidemic period. The attack rate is hard to predict, but in the past the average attack rate for districts with 100,000 to 500,000 inhabitants has been 300 to 1,400/100,000 (0.3 to 1.4%);
 - the desired buffer stock (generally 10 to 25%). The buffer stock for the first order can be larger to prevent shortages;
 - the expected proportion of hospitalised cases This varies with the context (population density, access to care, etc.): 10 to 20% seems reasonable;
 - the name of the district;
 - the total population;
 - the number of cases already reported.

The worksheet automatically calculates:

- the estimated number of cases for the outbreak;
- the number of cases expected (estimated cases minus already-reported cases);
- the buffer stock;
- the drug needs for treating all of the cases expected;
- the drug needs for treating the uncomplicated cases;
- the drug needs for treating the hospitalised complicated cases;

- the quantities of drugs and supplies needed to make up the treatment kits (kits 10 treatments “uncomplicated cases” and kits 20 treatments “complicated cases”).
- In the “Other items” table, enter useful items not included in the kits. These can be supplied with the first allocation.
- To determine the cost of the medical order, enter:
 - the currency used;
 - the unit price of each item (the price given is the suggested retail price in euros).

The worksheet automatically calculates:

- the cost for each item;
- the total cost of the order.

Appendix 10. Donation form - examples

See [Toolbox](#)

10.1 Kit 10 treatments « uncomplicated cases »

Médecins Sans Frontières donates to: _____

Region: _____ District: _____

This kit contains the following items:

Item	Presentation	Dosage	Quantity
Amoxicillin	tablet	500 mg	300
Paracetamol	tablet	500 mg	150
Retinol (vitamin A)	capsule	200 000 IU	10
Oral rehydration salts	sachet	–	40
Tetracycline eye ointment 1%	tube	5 g	10
Nystatin	oral suspension	100 000 IU/ml	5
Plastic bag for drugs	–	–	40

Number of kits 10 treatments « uncomplicated cases » delivered:

Other donations (thermometer, brachial perimeter bracelet, etc.):

This donation is reserved for the treatment of measles cases.
These treatments must be free of charge for the patients.

Date: _____

For Médecins Sans Frontières:

For the health facility:

One copy is to be kept by the donor, one by the director of the health facility.

10.2 Kit 20 treatments « complicated cases »

Médecins Sans Frontières donates to: _____

Region: _____ District: _____

This kit contains the following items:

Item	Presentation	Dosage	Quantity
Amoxicillin	tablet	500 mg	600
Amoxicillin	powder for oral suspension	125 mg/5 ml, 100 ml bottle	4
Amoxicillin/clavulanic acid	tablet	500 mg/62.5 mg	400
Nystatin	oral suspension	100 000 IU/ml	10
Paracetamol	tablet	500 mg	300
Paracetamol	tablet	100 mg	250
Paracetamol	oral suspension	120 mg/5 ml, 60 ml bottle	2
Retinol (vitamin A)	capsule	200 000 IU	45
Oral rehydration salts	sachet for 1 litre		80
Zinc sulfate	dispersible tablet	20 mg	100
Salbutamol spray	pressurised-dose inhaler	0.1 mg/puff	2
Ceftriaxone IV	vial	1 g	100
Cloxacillin IV	vial	500 mg	460
Dexamethasone	ampoule	4 mg (4 mg/ml, 1ml)	3
Diazepam	ampoule	10 mg (5 mg/ml, 2 ml)	5
Epinephrine (adrenaline)	ampoule	1 mg (1 mg/ml, 1 ml)	5
Paracetamol IV	vial	500 mg (10 mg/ml, 50 ml)	10
Water for injection	vial	10 ml	420
5% glucose + infusion set	plastic pouch	500 ml	15
Ringer lactate + infusion set	plastic pouch	500 ml	35
0.9% sodium chloride	plastic pouch	100 ml	120
Tetracycline eye ointment 1%	tube	5 g	15
0.9% sodium chloride	ampoule	5 ml	25
Infusion set, single use			100
Paediatric infusion set, graduated burette 150 ml, single use			5
Plastic bag for drugs			200
Syringe, single use		10 ml	400
Syringe, single use		5 ml	320
Syringe, single use		1 ml	10
Syringe for feeding, single use		60 ml	2

Needle, single use	19 G	400
Needle, single use	23 G	400
IV catheter, single use	22 G	20
IV catheter, single use	24 G	20
Stopper for IV catheter, single use		120
Scalp vein infusion set, single use	25 G	25
Nasogastric tube, single use	CH 06	2
Nasogastric tube, single use	CH 08	2
Canula, nasal, oxygen, 2 pronges, tube, paediatric		5
Cotton wool	500 g	1
Tourniquet		2
Gauze compress, non sterile, 10 cm, 12 plies		100
Bandage, extensible, non adhesive		10
Gloves, single use, non sterile	medium	400
Safety box	4 litres	1
10% polyvidone iodine, bottle	200 ml	1
Adhesive tape, roll		1
Brachial perimeter bracelet, paediatric		1

Number of kits 20 treatments « complicated cases » delivered:

Other donations (thermometer, oxygen concentrator, etc.):

**This donation is reserved for the treatment of measles cases.
These treatments must be free of charge for the patients.**

Date: _____

For Médecins Sans Frontières:

For the health facility:

One copy is to be kept by the donor, one by the director of the health facility.

Appendix 11. Treatment availability monitoring

The Excel file **TREATMENT AVAILABILITY MONITORING** (see [Toolbox](#)) contains several worksheets, some of them protected.

This file is used to:

- continuously monitor treatment availability at each facility for each district;
- identify locations where quick re-supply is needed;
- plan the supply of kits based on the epidemiological surveillance data and donation forms.

Using the worksheets

- Use one file for each region. Each file includes:
 - an automatic summary worksheet for the region;
 - fifteen “District” worksheets, named A through O. Do not create new worksheets.
- Fill in only the yellow boxes. Do not enter data into other boxes as this may modify the automatic calculations and generate errors.
- When doing the weekly update to the file, change the week number in the file name.

“District” worksheets

- When using for the first time:
 - Begin with the “District A” worksheet.
 - Enter the year, the name of the region, the name of the district and the total population.
 - Enter the source of the information (e.g., national surveillance system).
 - Enter the week number when treatment distribution began. Subsequent week numbers display automatically for all of the districts and for the region.
 - Treatment of uncomplicated cases: for each facility (health centre or hospital, if the latter offers outpatient treatment), enter its name and the total population served. The total population of the district is calculated automatically.
 - Treatment of complicated cases: only the district hospital or an inpatient unit receives these treatments. These are accounted for in a separate table.
 - Enter the name of the district on the tab.
- Each week:
 - Enter the number of cases and deaths for each health facility from the epidemiological data collection sheets. The totals and the case fatality rate are calculated automatically for each facility and for the district.

Note that if there are no cases, enter “zero” cases. Do not write “zero” cases if there is no data.

When the case fatality rate is over 5%, the corresponding cells display in red.

- Enter the number of treatments distributed from the donation forms.
Note: enter zero if there was no distribution during the week.
The number of treatments available at each facility and for the district is calculated automatically.
Number of treatments available = the total number of treatments distributed minus the cumulative number of cases reported over the same period.
- Weekly data analysis
 - If the case fatality rate is high, conduct a visit to the facility to determine the causes.
 - The quantity of available treatments should be equal to or greater than the estimated number of cases expected for the week (or the period corresponding to the distribution frequency).
 - The quantity of treatments needed is estimated according to the appearance of the epidemic curve, the vaccinations done or planned, and the supply interval.
 - Write the analysis in the weekly analysis cell: abnormally high CFR, causes, availability, priorities, necessary follow-up, etc.

“Region” worksheet

When using for the first time, enter:

- the total population of the region;
- the name of the region on the tab.

The worksheet automatically calculates:

- the cumulative number of cases and deaths and the case fatality rate for the districts and the hospitals;
- the number of treatments distributed and available for each district and for the hospitals.

This worksheet is protected and generated automatically from the worksheets for each district.

Appendix 12. Example of public information message

There is currently a measles outbreak in _____

Patient treatment

Consult your nearest health facility if a child or someone in your family has:

a fever and widespread skin rash
associated with
a cough or conjunctivitis (red, watery eyes) or nasal discharge (runny nose)

If the child's condition is worrying (breathing difficulties, drowsiness, seizures, diarrhoea, refusal to eat, etc.), take him to the hospital immediately.

During the outbreak, measles treatment is free of charge.

Vaccination

Everyone age 6 months to _____ years should be vaccinated against measles.

- Vaccinations will be performed from: _____ to _____
- Please go to the nearest vaccination site: _____

Measles vaccination is free of charge.

If you will be absent the day of the vaccination, go to the health facility as soon as possible.

Appendix 13. Case management

See [Toolbox](#)

Case definitions, triage and treatment

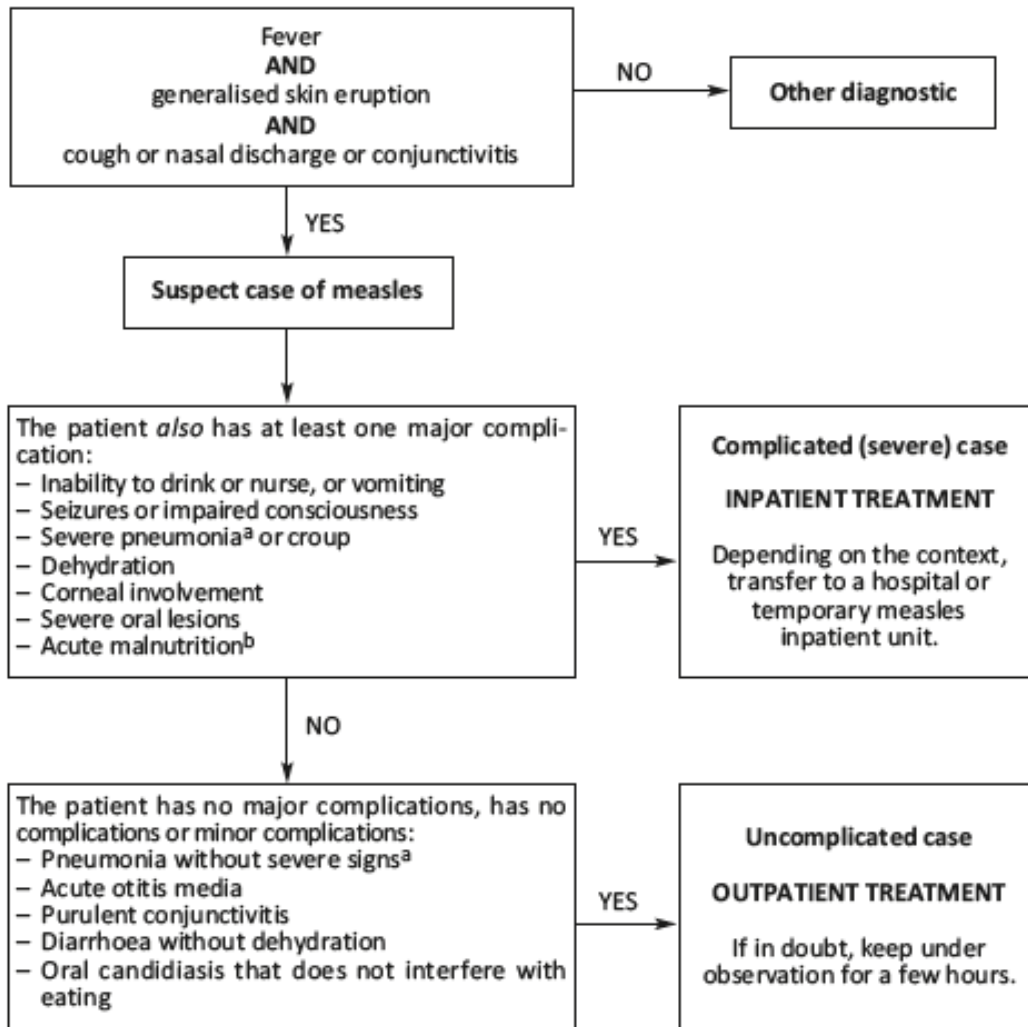

^a Pneumonia is always considered as severe in children less than 2 months of age or suffering from severe malnutrition.

^b Look for malnutrition only if justified by the context (food insecurity or crisis, or displaced population) and in children under age 3 or 5 years.

Uncomplicated cases (outpatient treatment)

Standard treatment

- Paracetamol PO: 20 mg/kg 3 times daily

Age	< 2 months	2-11 months	1-4 years	5-10 years	11-15 years	Adult
Weight	< 5 kg	5-9 kg	10-17 kg	18-32 kg	33-47 kg	
Oral sol. 120 mg/5 ml	3 ml x 3	4 to 10 ml x 3	–	–	–	–
100 mg tab	3/4 tab x 3	1 to 2 tab x 3	2 to 3 tab x 3	–	–	–
500 mg tab	–	–	½ tab x 3	½ to 1 tab x 3	1½ to 2 tab x 3	2 tab x 3

- **Amoxicillin** PO: 25 to 50 mg/kg 2 times daily for 5 days in children under 5 years

Age	< 2 months	2-11 months	1-4 years
Weight	< 5 kg	5-9 kg	10-17 kg
Oral susp. 125 mg/5 ml	½ tsp x 2	2 to 3 tsp x 2	–
250 mg tab	1 tab x 2	1 to 2 tab x 2	2 to 3 tab x 2
500 mg tab	–	–	1 to 2 tab x 2

- **Retinol*** (vitamin A) PO: one dose on Day1

Age	< 6 months	6-11 months	1 year and over
Weight	< 7.5 kg	7.5-9 kg	10 kg and over
Dose	50 000 IU	100 000 IU	200 000 IU
200 000 IU capsule (8 drops)	2 drops	4 drops	1 capsule

* *except in pregnant women*

- Wipe eyes with cotton and clean water.

- Keep nasal passages clear (using a tissue or by nasal lavage with 0.9% sodium chloride if appropriate).
- Depending on the context, for children < 3 or 5 years, food supplement: 500 kcal daily, ready-to-use food, 2 weeks.

Treatment of complications

- *Pneumonia without severe signs or acute otitis media*: **amoxicillin** PO 5 days
- *Purulent conjunctivitis*: clean the eyes with clean water + **tetracycline eye ointment 1%** (2 times daily, 7 days)
- Bitot's spots: **retinol** PO one dose on Day1, Day2, Day8
- Oral candidiasis: **nystatin** 100 000 IU/ml oral suspension (1 ml 4 times daily, 7 days)^a
- *Diarrhoea without dehydration*: WHO plan A

- Administer the first dose of treatments during the consultation.
- Advice to parents:
 - Make the child drink, give smaller, more frequent meals or breastfeed more frequently.
 - Keep the eyes clean, blow the child's nose frequently.
 - Bring the child back in if: his consciousness is impaired or in case of seizures, if he cannot drink or nurse, or is vomiting, if diarrhoea appears or worsens, if he has respiratory problems or ear pain or if fever persists after 2 days.
 - Family members with symptoms of measles should also come for consultation.

Complicated cases (inpatient treatment)

Standard treatment

- **Paracetamol** PO: 20 mg/kg 3 times daily

Age	< 2 months	2-11 months	1-4 years	5-10 years	11-15 years	Adult
Weight	< 5 kg	5-9 kg	10-17 kg	18-32 kg	33-47 kg	
Oral sol. 120 mg/5 ml	3 ml x 3	4 to 10 ml x 3	–	–	–	–
100 mg tab	3/4 tab x 3	1 to 2 tab x 3	2 to 3 tab x 3	–	–	–
500 mg tab	–	–	1/2 tab x 3	1/2 to 1 tab x 3	1 1/2 to 2 tab x 3	2 tab x 3

- Only in case of high fever in a child who is vomiting repeatedly or whose consciousness is impaired, **paracetamol IV**, 500 mg vial (10 mg/ml, 50 ml

Weight	< 10 kg	10-50 kg	> 50 kg
Dose to be administered every 6 hours (in mg)	7.5 mg/kg	15 mg/kg	1 g
Dose to be administered every 6 hours (in ml)	0.75 ml/kg	1.5 ml/kg	100 ml
Dose maximum	30 mg/kg/day	60 mg/kg/day	4 g/day

Administer paracetamol IV in 4 doses at 6-hour intervals. Each dose is administered over 15 minutes. Change to oral route as soon as possible.

- **Amoxicillin PO**: 25 to 50 mg/kg 2 times daily for 5 days in children under 5 years

Age	< 2 months	2-11 months	1-4 years	5-10 years	11-15 years	Adult
Weight	< 5 kg	5-9 kg	10-17 kg	18-32 kg	33-47 kg	
Oral susp. 125 mg/5 ml	1½ tsp x 2	2 to 3 tsp x 2	-	-	-	-
250 mg tab	1 tab x 2	1 to 2 tab x 2	2 to 3 tab x 2	-	-	-
500 mg tab	-	-	1 to 2 tab x 2	2 to 3 tab x 2	3 to 4 tab x 2	4 tab x 2

- **Retinol** (vitamin A) PO: one dose on Day1 and Day2

Age	< 6 months	6-11 months	1 year and over
Weight	< 7.5 kg	7.5-9 kg	10 kg and over
Dose	50 000 IU	100 000 IU	200 000 IU
200 000 IU capsule (8 drops)	2 drops	4 drops	1 capsule

Administer retinol PO in 2 doses (Day1, Day2) to all patients except:

- pregnant women (contra-indicated);
 - in the event of **corneal lesions** or **Bitot's spots** (in this case, give 3 doses, on Day1, Day2, Day8).
- Wipe eyes with clean water 2 times daily.
 - Keep nasal passages clear (using a tissue or by nasal lavage with 0.9% sodium chloride if appropriate).
 - Give caloric food, smaller, more frequent meals or breastfeed more frequently.
 - Make the child drink regularly.
 - Depending on the context, for children < 3 or 5 years, food supplement: 500 kcal daily, ready-to use food, 2 weeks.

Respiratory and ENT complications

Severe pneumonia

- **Oxygen** if cyanosis or SpO₂ < 90%

- **Ceftriaxone** slow IV or IM (1 g to be dissolved in 5 ml): 100 mg/kg once daily

Age	1-11 months	1-4 years	5-10 years	11-15 years	Adult
Weight	4-9 kg	10-17 kg	18-32 kg	33-47 kg	
Dose	400 to 900 mg	1 to 1.5 g	2 to 3 g	3 to 4 g	4 g
Volume to be injected (1 g vial /5 ml of diluent)	2 to 5 ml	1 to 1½ vial	2 to 3 vials	3 to 4 vials	4 vials



IV injection:

When ceftriaxone is administered by IV route, the powder (1 g) must be dissolved in 5 ml of water for injection.

IM injection:

Vials of ceftriaxone for IM injection are provided with a specific diluent containing lidocain. **Once reconstituted with this diluent, ceftriaxone can be administered by IM route only, NEVER BY IV ROUTE.** Doses (in ml or vials) in the table above are based on a ceftriaxone concentration of 1 g diluted in 5 ml of diluent with lidocain. Always verify the dosage and the volume of diluent as they can vary according to the manufacturers (500 mg/2 ml, 500 mg/5 ml, 1 g/5 ml, 1 g/10 ml, etc.). All of the diluent must be used for reconstitution. If the volume to be injected is large, administer half the dose into each buttock.

PLUS

- **Cloxacillin** IV infusion over 60 minutes (500 mg to be dissolved in 5 ml water for injection): 25 to 50 mg/kg every 6 hours

Age	< 2 months	2-11 months	1-4 years	5-10 years	11-15 years	Adult
Weight	< 5 kg	5-9 kg	10-17 kg	18-32 kg	33-47 kg	
Dose	200 mg x 4	250 to 400 mg x 4	500 to 750 mg x 4	1 g x 4	1.5 g x 4	2 g x 4
Volume to be injected (500 mg vial /5 ml)	2 ml x 4	2.5 to 4 ml x 4	1 to 1½ vial x 4	2 vials x 4	3 vials x 4	4 vials x 4

Parenteral treatment for at least 3 days then, once the child no longer has fever or clinical signs of severe infection, change to **amoxicillin/clavulanic acid** PO: 40 mg/kg 2 times daily to complete 7 to 10 days of treatment

Age	< 2 months	2-11 months	1-4 years	5-10 years	11-15 years	Adult
Weight	< 5 kg	5-9 kg	10-17 kg	18-32 kg	33-47 kg	
Oral susp. 100 + 12.5 mg/5 ml	8 ml x 2	12 ml x 2	–	–	–	–
500/62,5 mg tab	–	–	1 tab x 2	2 tab x 2	3 tab x 2	3 tab x 2

Pneumonia (without signs of severity)

- **Amoxicillin** PO: 25 to 50 mg/kg 2 times daily for 5 days

Age	< 2 months	2-11 months	1-4 years	5-10 years	11-15 years	Adult
Weight	< 5 kg	5-9 kg	10-17 kg	18-32 kg	33-47 kg	
Oral susp. 125 mg/5 ml	1½ tsp x 2	2 to 3 tsp x 2	–	–	–	–
250 mg tab	1 tab x 2	1 to 2 tab x 2	2 to 3 tab x 2	–	–	–
500 mg tab	–	–	1 to 2 tab x 2	2 to 3 tab x 2	3 to 4 tab x 2	4 tab x 2

As a second line (treatment failure after 48 hours), **amoxicillin/clavulanic acid** PO: 40 mg/kg 2 times daily for 7 days (see [Severe pneumonia](#)).

Acute otitis media

- **Amoxicillin** PO: 25 to 50 mg/kg 2 times daily for 5 days (see above)
- If there is discharge from the ear, keep the ear clean by wiping the external auditory canal with dry cotton wool.

Severe laryngotracheobronchitis (croup)

- **Dexamethasone** (1 ml ampoule, 4 mg/ml) IM: 0.6 mg/kg single dose

Age	< 2 months	2-11 months	1-4 years	3-4 years
Weight	< 5 kg	5-9 kg	10-13 kg	14-17 kg
Dose	2 mg	4 mg	8 mg	10 mg
Volume to be injected	0.5 ml	1 ml	2 ml	2.5 ml

- Nebulized **epinephrine** (1 mg ampoule, 1 mg/ml): 0.5 ml/kg per dose

Age	1 month	2 months	3 months	4-6 months	7-9 months	10-11 months	1-4 years*
Weight	4.5 kg	5 kg	6 kg	7 kg	8 kg	9 kg	10-17 kg
Epinephrine (1 mg/ml ampoule)	2 ml	2.5 ml	3 ml	3.5 ml	4 ml	4.5 ml	5 ml
0.9% NaCl to be added	2 ml	2 ml	1 ml	1 ml	–	–	–

* In children > 4 years or > 17 kg, the dose should not exceed 5 ml.

- **Oxygen** if cyanosis or SpO₂ < 90%

Ocular complications

Corneal lesions (opacification, ulcer)

- **Retinol** (vitamin A) PO: one dose on Day1, Day2, Day8

Age	< 6 months	6-11 months	1 year and over
Weight	< 7.5 kg	7.5-9 kg	10 kg and over
Dose	50 000 IU	100 000 IU	200 000 IU
200 000 IU capsule (8 drops)	2 drops	4 drops	1 capsule

- **Tramadol** PO if ocular pain:

- Child over 12 years and adult: 50 to 100 mg every 6 hours (max. 400 mg daily)

Age	> 12 years	Adult
Dose	50 mg x 4	100 mg x 4
Gél 50 mg	1 cap x 4	2 cap x 4

- Keep the eye clean: clean with 0.9% sterile sodium chloride and apply **tetracycline eye ointment 1%**, 2 times daily, to prevent or treat bacterial superinfection.
- Protective dressing as long there is photophobia.

Bitot's spots

- **Retinol** (vitamin A) PO: one dose on Day1, Day2 and Day8, as above

Purulent conjunctivitis

- Clean the eyes with clean water 2 times daily.
- **Tetracycline eye ointment 1%**: one application 2 times daily for 7 days

Gastrointestinal complications

Oral candidiasis

- **Nystatin** PO: 1 ml of oral suspension (100 000 IU) 4 times daily for 7 days^a . If there is no improvement after 3 days, increase the dose to 200 000 IU 4 times daily.

Diarrhoea without dehydration

WHO treatment plan A

Diarrhoea with dehydration

- Rehydration:
Moderate (some) dehydration: WHO treatment plan B
Severe dehydration: WHO treatment plan C
- +
- **Zinc sulfate** (20 mg dispersible tablet):
 - Child under 6 months: 10 mg once daily for 10 days (= ½ tab daily)
 - Child from 6 months to 5 years: 20 mg daily for 10 days (= 1 tab daily)In infants: place ½ or 1 tablet in a teaspoon and add a bit of water to dissolve it.
In children over 2 years: tablets may be chewed or dissolved.
Ask the parents not to remove the tablets from the blister-pack. Once a tablet is removed from the blister-pack, it must be administered immediately.

Other complications

Acute malnutrition

Follow the protocol for managing malnutrition (RT UF).

Seizures

Generalised seizure lasting > 3 minutes:

- **diazepam**: 10 mg ampoule (5 mg/ml, 2 ml)
Child: 0.5 mg/kg rectally, without exceeding a total dose of 10 mg
- For intrarectal administration, use a 1 ml-syringe graduated in 0.01 ml (with no needle). Introduce the tip of the syringe into the rectum (1.5 to 4 cm depending on age).

Age	< 4 months	4-11 months	1-2 years
Weight	< 7 kg	7-9 kg	10-13 kg
Dose in mg	2.5 mg	4 mg	6 mg
Volume to be administered	0.5 ml	0.8 ml	1.2 ml

If seizures persist after 5 minutes after the first dose, repeat the same dose once.

If the patient is to be transferred to a hospital

- Administer the first dose of amoxicillin PO and paracetamol PO.
- Severe dehydration: place a IV line and transfer the patient when stable.
- Moderate (some) dehydration: the patient should be able to drink ORS while being transferred.
- Corneal lesion: protect the eye with a dry dressing.
- Send the patient with a transfer form indicating the reason for the referral and treatments administered.

Footnotes

(a) If not available, 0.25% gentian violet, applied 2 times/day for 5 days maximum.

Appendix 14. Plan rehydration WHO

Appendix 14. Plan rehydration WHO

Table 1: Assessment of dehydration

	A	B	C
1. Look at:			
Condition ^a	Well, alert	Restless, irritable	Lethargic or unconscious
Eyes ^b	Normal	Sunken	Sunken
Thirst	Drinks normally, not thirsty	Thirsty, drinks eagerly	Drinks poorly or not able to drink
2. Feel:			
Skin pinch ^c	Goes back quickly	Goes back slowly	Goes back very slowly
3. Decide:	The patient has no signs of dehydration	If the patient has two or more signs in B, there is some dehydration	If the patient has two or more signs in C, there is severe dehydration

See [Toolbox](#)

Appendix 15. Clearing of the nasopharynx (nasal irrigation)

Nasal irrigation is indicated in children with breathing difficulties due to upper airway obstruction from secretions. It should be performed one hour before or after a feed or a meal if possible. There are two methods: the instillation method and the volumetric method.

15.1 Instillation technique (done by parents, at home)

- Wash hands.
- Lay the child on his back.
- Instil 2 to 4 drops of normal saline in each nostril when the child inhales.
- Raise the child (to a semi-seated position) and collect the secretions from the nose and mouth with a tissue.
- Wash hands.

15.2 Volumetric technique (done by care provider at an outpatient visit or in the hospital)

- Wash hands.
- Lay the child on his back, head slightly elevated.
- Placing one hand under his neck, turn his head to the right to treat the left nostril.
- Insert the dropper tip of the normal saline vial at the opening of the left nostril.
- Squeeze the vial when the child inhales.
- If the child coughs, stop the instillation and let him settle down for a few minutes.
- Check that the saline and secretions have drained via the right nostril.
- Raise the child's head slightly so that the fluid can drain more easily.
- Collect the secretions.
- Repeat the procedure on the other side.
- Monitor the child for a few minutes after the procedure.
- Wash hands.

Appendix 16. Epinephrine nebulization

Nebulised epinephrine (adrenaline) is indicated in severe acute laryngotracheobronchitis (in combination with dexamethasone by IM injection).

It must be prescribed by a doctor and should only be repeated on medical prescription.

16.1 Dosage

0.5 ml/kg/dose (using 1 mg/ml ampoule). Do not exceed 5 ml of nebulised epinephrine.

See [table](#).

16.2 Equipment

- Epinephrine, 1 mg/ml ampoule(s)
- 0.9% sodium chloride, if necessary
- Nebuliser + electric air compressor
- Clean tray
- Single patient equipment: paediatric mask + tubing
- 5 ml syringe + 19G needle, single use

16.3 Technique

Aerosol preparation (just before use)

- Verify the prescription: name, prescribed dose, concentration of epinephrine in the ampoule.
- Prepare the equipment.
- Wash hands with soap and water or disinfect them with an alcohol-based solution.
- Open the nebulizer.



- Using the syringe, place the prescribed amount of epinephrine in the lower part of the nebulizer.
- Add enough 0.9% sodium chloride to obtain a total volume of 4 to 4.5 ml in the medicine cup.

Nebulised epinephrine dose by age or weight

Age	1 month	2 months	3 months	4-6 months	7-9 months	10-11 months	1-4 years	> 4 years
Weight	4.5 kg	5 kg	6 kg	7 kg	8 kg	9 kg	10-17 kg	> 17 kg
Epinephrine (1 mg/ml amp.)	2 ml	2,5 ml	3 ml	3,5 ml	4 ml	4,5 ml	5 ml	5 ml
0.9% NaCl to be added	2 ml	2 ml	1 ml	1 ml	-	-	-	-

- Screw the top of the nebulizer back on.

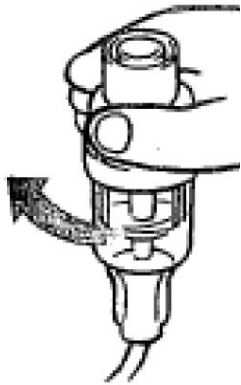

- Connect the nebulizer to the mask.

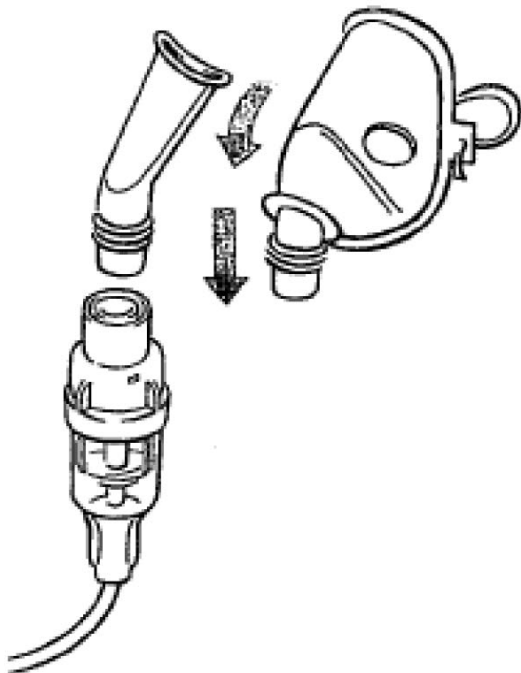

- Dispose of sharps in a safety box.

Administering the aerosol

- Explain the procedure to the child and the person accompanying him: the inhalation lasts about 10 minutes; keep the mask on and breathe slowly and deeply the entire time.
- Have the parents hold the child in a half-seated position.
- Clear the nose, if necessary.
- Attach the tubing to the compressor.
- Start the compressor. Make sure there is mist coming out of the mask.
- Place the mask over the child's mouth and nose; secure it in place with the strap.
- The inhalation should last no longer than 10 to 12 minutes. Stop the compressor after 10 to 12 minutes (or sooner, if all of the medicine has been nebulised).
- Record the procedure in the patient's chart.

Monitoring

- Before nebulization: heart rate, respiratory rate and, if possible, SpO₂.
- During the nebulization and for 4 hours afterward:
 - general condition, level of consciousness, respiratory rate, and SpO₂;
 - signs of improvement: decreased stridor and improvement in ventilation, level of consciousness and SpO₂;
 - alert the doctor in case of pallor, tachycardia, arrhythmia, or drop in SpO₂ (< 90%).
- Record the monitoring data in the patient's chart.

16.4 After using the equipment

- Discard the tubing and mask.
- Disassemble the nebulizer and clean all of the parts in soapy water, taking care not to damage the jet (do not use a brush).
- For equipment maintenance (jet, compressor air filter), refer to specific protocol.

Appendix 17. Example of vaccination campaign timetable

Dates	Person responsible	Start of outbreak																	Start of campaign																	End				
		D1	D2	D3	D4	D5	D6	D7	D8	D9	D10	D11	D12	D13	D14	D15	D16	D17		D1	D2	D3	D4	D5	D6	D7	D8	D9	D10	D11	D12	D13	D14	D15	D16	D17		
Outbreak management committee																																								
Role, duties, composition																																								
Creation/reactivation																																								
Meetings																																								
Assessment and activity report																																								
Public information/social mobilisation																																								
Set up of public information committee																																								
Committee meetings																																								
Drafting of message																																								
Preparation and distribution of materials																																								
Dissemination of message																																								
Human resources																																								
Assessment of existing personnel/needs																																								
Identification and allocation of personnel																																								
Team schedules																																								
Design of training/supervision documents																																								
Training and distribution of documents																																								
Supervision																																								
Per diem																																								

See [Toolbox](#)

Appendix 18. Estimating needs - Vaccines and injection supplies

The Excel file **ESTIMATING NEEDS - VACCINES AND INJECTION SUPPLIES** for vaccination (see [Toolbox](#)) contains several worksheets, some of them protected.

This file is used to estimate needs and prepare vaccine and injection supply orders in each district.

Using the worksheets

- Each file has five “District” worksheets, named A through E. Use one worksheet per district. If necessary, create new worksheets.
- Fill in only the yellow boxes. Do not enter data into other boxes as this may modify the automatic calculations and generate errors.

“District” worksheet

Enter:

- the name of the region and district;
- the target population: age group and percentage;
- the volume of one dose of vaccine in cm^3 ;
- the number of doses per vaccine vial;
- the percentage of reserve (or buffer) stock desired (10 to 25%);
- the name of the district on the tab.
- for each location: the name of the location to be vaccinated, total population, population already vaccinated.

The worksheet automatically calculates:

- for each location: the target population (total number of persons), population to be vaccinated, number of doses of vaccines needed, volume of vaccines in litres, number of ADS, syringes and needles for dilution, safety boxes, gloves and cotton wool needed;
- for the district: the total for all items.

Appendix 19. Cold chain equipment

19.1 Refrigerators and freezers

Equipment <i>Type of energy</i> <i>Net weight</i>	Refrigerators	Freezers	
	Storage capacity in litres and doses of vaccines^(a) (vaccines without diluents, 10-dose vials)	Icepack storage capacity	Ice production/24h (for electricity supply 24h/24)
Refrigerator/freezer V 170 Sibir® <i>EK^(b) (88 kg)</i> <i>EG^(c) (68 kg)</i>	55 litres = 22 000 doses	37 litres 30 ice packs 0.6 litre or 38 ice packs 0.4 litre	EK: 0.96 kg/24h EG: 1.2 kg/24h
Refrigerator MK 144 Vestfrost® <i>Electricity 220 V</i> <i>min. required: 8h/24h</i> 74 kg	45 litres = 18 000 doses		
Refrigerator MK 204 Vestfrost® <i>Electricity 220 V</i> <i>min. required: 8h/24h</i> 78 kg	75 litres = 30 000 doses		
Refrigerator MK 304 Vestfrost® <i>Electricity 220 V</i> <i>min. required: 8h/24h</i> 97 kg	105 litres = 42 000 doses		
Freezer MF 114 Vestfrost® <i>Electricity 220 V</i> <i>min. required: 8h/24h</i> 64 kg		72 litres: 110 ice packs 0.6 litre or 150 ice packs 0.4 litre	17.5 kg/24h 29 ice packs 0.6 litre or 42 ice packs 0.4 litre
Freezer MF 214 Vestfrost® <i>Electricity 220 V</i>		192 litres: 213 ice packs 0.6 litre or	22.8 kg/24h 38 ice packs 0.6 litre or 57 ice packs 0.4 litre

<i>min. required: 8h/24h</i> <i>71 kg</i>		290 ice packs 0.4 litre	
Freezer MF 314 Vestfrost® <i>Electricity 220 V</i> <i>min. required: 8h/24h</i> <i>87 kg</i>		264 litres: 323 ice packs 0.6 litre or 450 ice packs 0.4 litre	32.4 kg/24h 54 ice packs 0.6 litre or 81 ice packs 0.4 litre

(a) Estimated number of doses, for a volume of 2.5 cm³ per dose.

(b) EK = electricity or kerosene

(c) EG = electricity or gas

19.2 Transport of vaccines

Equipment <i>Weight (with ice packs filled with water)</i>	Storage capacity in litres and doses of vaccines^(d) (vaccines without diluents, 10-dose vials)	Characteristics	Autonomy of conservation for vaccines (without opening, external temperature 43 °C)
Cold box RCW 12 Electrolux® <i>21 kg</i>	8.5 litres = 3 450 doses	14 ice packs 0.6 litre	114 hours
Cold box RCW 25 Electrolux® <i>32.8 kg</i>	20.7 litres = 8 410 doses	24 ice packs 0.6 litre	129 hours
Vaccine carrier Giostyle® <i>6.5 kg</i>	2.6 litres = 1 000 doses	8 ice packs 0.4 litre	32 hours

(d) Estimated number of doses, for a volume of 2.5 cm³ per dose.

19.3 Monitoring tools

Equipment	Monitoring tools
Refrigerators	LogTag® recording thermometer or Fridge tag® recording thermometer If not available, Thermometer, alcohol, Moeller PLUS Stop!Watch® card with Freeze tag® Temperature monitoring sheet
Freezers	LogTag® recording thermometer or Thermometer, alcohol, Moeller PLUS Temperature monitoring sheet
Cold box RCW25 and RCW12 For use on vaccination sites	Thermometer, liquid crystal display (LCD)
Vaccine carrier For use on vaccination sites	No thermometer Check VVM

Appendix 20. Cold chain evaluation/inventory

See [Toolbox](#)

Country: _____ Province/region: _____

District: _____ Health care facility: _____

Person in charge: _____ Date: _____

	Yes	No
1 - Is there a person in charge of the cold chain? If yes, person's name and contact information:		
2 - Is the room well-ventilated?		
3 - Is the equipment protected from the sun?		
4 - If electricity is available, is it reliable? Specify the number of hours of electricity per day:		
5 - Is the distance between the wall and the refrigerator/freezer greater than or equal to 30 cm?		

6 - Refrigerators:

Brand, model	Number	Energy source^(a)	Storage volume (in litres)	Available volume (in litres)	Monitoring equipment present Y/N^(b)

(a) Specify the energy source, the electrical power and the availability (number of hours/day).

(b) One thermometer, one Stop!Watch® card with a Freeze-tag® and one temperature monitoring sheet per refrigerator.

7 - Freezers:

Brand, model	Number	Energy source^(c)	Storage volume		Ice production per 24 hours		Monitoring equipment present Y/N^(d)
			In litres	In nb 0.6-litre ice packs	In kg/24h without vaccines	In nb 0.6-litre ice packs	

- (c) Specify the energy source, the electrical power and the availability (number of hours/day).
- (d) One thermometer and one temperature monitoring sheet per freezer.

8 - Transport equipment:

Vaccine carrier, brand and model	Total number	Number available	Vaccine storage volume (in litres)
Cold box, brand and model	Total number	Number available	
Ice packs	Total number	Number available	
0.6 litre			
0.4 litre			
Other (<i>specify volume</i>)			

9 - Monitoring equipment:

Equipment	Total number available/functional
Fridge-Tag [®] or Logtag [®] (with display) temperature logger	
Moeller [®] alcohol thermometer	
Thermometer with liquid-crystal display (LCD)	
Other thermometer (<i>specify</i>):	
Refrigerator monitoring card (Stop!Watch [®] with Freeze-tag [®])	
Freeze indicator (Freeze-tag [®])	

Appendix 21. Cold chain equipment technical sheets

N°

REFRIGERATOR

Brand:

Model:

Net storage capacity: litres

Gross storage capacity: litres

Holdover time without power at 43°C: hours

Drugs in stock:

Presence of temperature monitoring tools:

Date: Thermometer Temperature monitoring sheet Stop!Watch®

N°

FREEZER

Brand:

Model:

Gross storage capacity: litres = icepacks

Freezing capacity: kg/24h = icepacks

Holdover time without power at 43°C: hours

Icepacks in stock: 0.6 litre 0.4 litre Other

Presence of temperature monitoring tools:

Date: Thermometer Temperature monitoring sheet

N°

FRIDGE/FREEZER

Brand:

Model:

Fridge net storage capacity: litres

Freezer net storage capacity: litres

Freezing capacity: kg/24h = icepacks

Holdover time without power at 43°C: hours

Drugs in stock:

Icepacks in stock: 0.6 litre 0.4 litre Other

Presence of temperature monitoring tools:

Date: Thermometer Temperature monitoring sheet Stop!Watch®

See [Toolbox](#)

Appendix 22. Temperature monitoring form

RELEVÉ DE TEMPERATURE							
Type de matériel/identification :				Lieu :			
Mois :							
Date	Température		Analyse des contrôles		Signature	Remarque	Entretien
	Matin	Soir	Cocher si T° < 2 ou > 8°C	Stop!Watch* (1)			
1							
2							
3							
4							
5							
6							
7							Dépoussiérer extérieur Talquer/contrôler joint Vérifier flamme/mèche (gaz, pétrole) Contrôler givre Signature :
8							
9							
10							
11							
12							
13							
14							Dégivrer/nettoyer Contrôler rouille Vérifier flamme/mèche (gaz, pétrole) Nettoyer cheminée (gaz, pétrole) Signature :
15							
16							
17							
18							
19							
20							
21							Dépoussiérer extérieur Talquer/contrôler joint Vérifier flamme/mèche (gaz, pétrole) Contrôler givre Signature :
22							
23							
24							
25							
26							
27							
28							
29							
30							
31							

(1) Stop!Watch* : si le Freeze-tag* indique X (ALARM) : noter FT = X
 si l'indicateur 3M vire au bleu, noter 3M et les lettres des cases colorées (p.ex. 3M A, 3M AB, 3M ABC, 3M D)

Bilan et analyse du mois

Nombre de jours où un problème de T° a été détecté (< 2°C ou > 8°C) :

Stop!Watch* viré (préciser si FT ou 3M) :

Réparation(s) effectuée(s) (Oui/Non. Si oui, préciser quel type de réparation et date) :

Nom du réparateur :

See [Toolbox](#)

Appendix 23. Estimating needs - Freezing capacity for a vaccination campaign

The Excel file **ESTIMATING THE FREEZING CAPACITY** for a vaccination campaign (see [Toolbox](#)) contains several tabs, some of them protected.

This file automatically calculates needs as a function of the data entered (campaign schedule and duration, cold chain equipment, sites and number of vaccination teams, freezer inventory, etc.).

Using the worksheets

- Each file contains:
 - three sample worksheets: vaccination schedule by location, vaccination schedule by team, estimating freezing capacity;
 - three “Freezing estimate” worksheets, labelled A to C. Use one worksheet per zone or district. If necessary, create new worksheets.
- Fill in only the yellow boxes, do not enter data into other boxes as this may modify the automatic calculations and generate errors.

For each worksheet

1) Define the cold chain equipment for one vaccination site:

- One vaccination site can accommodate one or two teams, at most.
- One cold box and one vaccine carrier are needed for each team.
- The number of ice packs is adjusted depending on the outside temperature.

Check the yellow boxes for the temperature (less than or ≥ 40 °C) and the interval for replacing the ice packs in the cold boxes (1, 2 or 3 days).

The worksheet automatically calculates:

- Table A:
 - number of cold boxes and vaccine carriers per team;
 - number of ice packs per cold box and vaccine carrier;
 - total number of ice packs at D1.
- Table B: number of ice packs needed per day for one and two teams at one site.

2) Estimate the number of ice packs needed each day for all of the teams and sites. In Table C, enter:

- Name of the district or zone covered.
- Name of the towns/locations and sites.
- For each site, specify the number of teams and their identification according to the vaccination schedule established.
- Then enter the number of ice packs needed per day and per site as a function of the number of teams, taken from Table B.

The total need in ice packs per day is calculated automatically.

3) Determine the available and required freezing capacities.

From the inventory, fill in one line in Table D for each type of working freezer available.

The worksheet automatically calculates:

- total freezing capacity available;
- total ice pack storage capacity;
- total freezing capacity per day;
- number of days to allow so that all of the ice packs can be frozen by D1.

4) Change in ice pack needs per day for the sites

On D1, note the maximum number of ice packs that can be stored or the maximum number of frozen ice packs available on D1.

The worksheet automatically calculates:

- balance = number of ice packs available each day;
- out = total number ice packs given per day to vaccination site teams;
- in = total number of ice packs that can be frozen per day.

Any negative quantity means that there will not be enough ice packs to supply all the teams. **Note:** this amount must not exceed the number of ice packs that can be stored in all of the available freezers combined.

If the number of freezers is insufficient, increase freezing capacity: add enough additional freezers in Table D to supply all of the sites for the anticipated duration of the campaign.

Appendix 24. Immunization kit, 10,000 vaccinations/ 5 teams (KMEDKIMM3–)

The kit enables immunization of people affected by an outbreak in refugee camps or an open setting. It is also used for setting up measles vaccination during an influx of refugees.

It contains the cold chain, logistics and medical equipment needed to quickly set up an emergency vaccination campaign. The kit provides the necessary items for the immunization of 10,000 people. The refrigerators and freezers are enough to supply five vaccination teams.

The kit's modular design allows adapting orders to existing equipment and coping with an increase in the target population. Additional modules can be ordered separately. If a large number of optional items are needed, it is better to order complete modules than separate items.

The refrigeration and passive cold chain modules have the storage capacity for vaccinating up to 20,000 people per day.

Vaccines must be ordered separately.

In accordance with the WHO policy on injection safety, always use auto-disable syringes and single-use safety boxes for collecting, transporting and incinerating sharps during mass vaccination campaigns.

Before placing an order, it is necessary to:

- Know the number of people that will be vaccinated, the number of teams that will be set up, and the duration of the campaign.
- Make sure that existing equipment is actually available and in good working order. Generally, a storage volume of about 30 litres is needed for each 10,000 doses of measles vaccine (not including diluent). All of the refrigerators used for EPI have this capacity, except for Electrolux Model RCW42.
- Find out about the ice pack freezing capacity:
 - Vapour compression freezers (freezers that have a compressor and run on electricity) can freeze 10 to 30 kg/24 hours (that is, fifteen to fifty 0.6-litre ice packs/24 hours).
 - Absorption freezers (freezers that do not have a compressor and run on kerosene or gas) can freeze 4 kg/24 hours (that is, six 0.6-litre ice packs/24 hours).
 - Solar models do not have sufficient freezing capacity for a vaccination campaign.
- Know the availability and reliability of round-the-clock electricity. If in doubt, order the energy kit. The generator can power a maximum of six refrigerators.
- Inventory the vaccine transport and monitoring supplies. Each team should have its own supplies. For additional cold boxes and vaccine carriers, order the cold chain transport module.

List of articles	MSF code	Qty
(module immunization, 10 000 vacc.) REFRIGERATION	KMEDMIMM30-	1
Cold chain guidelines	L015COLG02E	1
FREEZER, 323 litres (Vestfrost MF 314), 230 V	PCOLFREE3E-	1
REFRIGERATOR, 204 litres (Vestfrost MK 304), 230 V	PCOLFRID3E-	1
BOARD, MULTI-OUTLET, 3 sockets, protection	PELEBOAR02P	1
CABLE EXTENSION, 10 m, 3 x 2.5 mm ² , EUR Plug	PELECABE102	3
PLUG, ADAPTOR, universal male UK+US+FR / female EUR	PELEPLUAUNE	2
PLUG, male, rubber (16 A + earth) EUR std	PELEPLUGER2	2
VOLTAGE REGULATOR/STABILIZER, 230 V, 2500 VA	PELEVOLS250	1
(module refrigeration) ACTIVE COLD CHAIN MONITORING	KMEDMIMM301	1
▶ MONITOR CARD, refrigerator (Stop!Watch [®])	PCOLCONT2R-	5
▶ FORM, temperature monitor, twice-daily	PCOLCONT4CT	5
▶ MONITOR CARD, refrigeration, electronic (Fridge-tag [®])	PCOLCONT5--	1
▶ THERMOMETER, ALCOHOL (Moëller 104614), -40°C to +50°C	PCOLTHER1A-	5
(module immunization, 10 000 vacc.) PASSIVE COLD CHAIN	KMEDMIMM31-	1
VACCINE CARRIER, 2.6 l (Gio Style) + 8 icepacks 0.4 l	PCOLBOXC03G	5
COLD BOX, 20.7 l (Electrolux RCW 25/CF) + 24 icepacks 0.6 l	PCOLBOXC22E	5
ICEPACK, empty, for water, 0.4 l (Gio Style)	PCOLPACKW04	160
ICEPACK, empty, for water, 0.6 l (Dometic)	PCOLPACKW06	240
THERMOMETER, LIQUID CRISTAL, LCD, 0° to 20°C	PCOLTHER3C-	10

(module immunization, 10 000 vacc.) LOGISTIC EQUIPMENT	KMEDMIMM33-	1
PLASTIC SHEETING, white/white, 6 bands, sheet, 4 x 6 m	CSHEPLASWS4	15
ROPE, Ø 5 mm, POLYPROPYLENE, twisted, per meter	CSHEROPE05P	500
JERRYCAN, collapsible, 20 l, food grade plastic, screw cap	CWATCONT20F	5
(collapsible jerrycan 20 l) TAP, screwless type 5 cm	CWATCONT20T	5
CUP, 250 ml, plastic, graduated	PCOOCUPP2G-	10
COMBINATION PLIERS, sheathed, 185 mm long	F187.18CPE	5
CUTTER, 18 mm, retractable, snap-off blade	F844.SE18	5
TIE, self-locking head, plastic, black, 6 x 300 mm	PELETIES300	500
WIRE, TIE, galvanized, Ø 1.1 mm, 50 m, roll	PHDWWIRET11	5
LAMP, TORCH, manual recharge + 12V DC, large model	PLIGLAMPTR1	5
TAPE, adhesive, PVC, white (roll)	PPACTAPE1W-	10
GLOVES, HEAVY DUTY, with leather protection, pair	PSAFGLOVW1-	5
NET, BOUNDARY MARKING, 1 x 50 m, roll	PSAFNETB1R5	5
TAPE, BOUNDARY MARKING, white/orange, fluo., 500 m roll	PSAFTAPE2BF	5
(module logistic equipment) KIT MEGAPHONE, for distribution	KCOMKMEG01-	1
▶ COUNTER, manual	ALIFCOUN1M-	2
▶ MEGAPHONE, 6 W min., battery powered	PCOMMEGA12B	1
▶ CHARGER, for R6 NiCD & NiMH batteries, 110-240 VAC / 12 VDC	PELEBATCR06	1
▶ BATTERY, rechargeable, NiMH, 1.2 V, R6 (AA)	PELEBATTR06	16
▶ MSF ARMBAND	PIDEARMB1--	2

▶ BADGE, MSF, plastic	PIDEBADG1MP	6
▶ TAPE, BOUNDARY MARKING, white/orange, fluo., 500 m roll	PSAFTAPE2BF	1
▶ (module megaphone) STATIONERY	KADMMSTA04-	1
• CLIPBOARD, fold over, A4	ASTAHOLD1P-	2
• NOTEPAD, A4, squared	ASTANOTP2S2	2
• PEN, BALL POINT, black	ASTAPENB1B-	6
• MARKER, permanent, large, chisel point, black	ASTAPENM3BB	12
(module immunization, 10 000 vacc.) RENEW. MEDICAL SUPPLIES	KMEDMIMM34-	1
SOAP, 200 g, bar	DEXTSOAP1B2	5
COTTON WOOL, hydrophillic, roll, 500 g	SDRECOTW5R-	20
CONTAINER, needles/syringes, 15 l, cardboard for incineration	SINSCONT15C	50
NEEDLE, s.u., Luer, 19G (1.1 x 40 mm) cream, IV	SINSNEED19-	1000
SYRINGE, AUTO-DISABLE with needle, s.u., imm, 0.5 ml	SINSSYAI005	11000
SYRINGE, s.u., Luer, 10 ml	SINSSYDL10-	1000
GLOVES, EXAMINATION, latex, s.u. non sterile, medium	SMSUGLOE1M-	500
(module immunization, 10 000 vacc.) MEDICAL EQUIPMENT	KMEDMIMM35-	1
BUCKET + LID, 10 l, plastic, white	CWATBUCK10W	10
JERRYCAN, collapsible, 20 l, food grade plastic, screw cap	CWATCONT20F	5
(collapsible jerrycan 20 l) TAP, screwless type 5 cm	CWATCONT20T	5
POLYVIDONE IODINE, 10%, solution, 200 ml, dropper bot.	DEXTIODP1S2	5
COAT, MEDICAL, white, large	ELINCOAW1L-	20

BRUSH, nail scrubbing, plastic, autoclavable	EMEQBRUS1--	5
KIDNEY DISH, 26 cm x 14 cm, stainless steel	EMEQKIDD26-	20
SCISSORS, blunt/blunt, straight, DRESSING, 14.5 cm 03-02-14	ESURSCOP4SB	10
Organisation d'une campagne de vaccination de masse DVD	L015IMMD01EF	1
BAG, REFUSE, 100 litres, black, 70 microns	PHYGBAGR1B7	250
PAPER, KITCHEN, roll	PHYGPAPK25-	20
SPONGE, double-sided	PHYGSPON2-	10
GLOVES, HEAVY DUTY, with leather protection, pair	PSAFGLOVW1-	5
(module immunization, 10 000 vacc.) STATIONERY	KADMMSTA32-	1
NOTEBOOK, A4, squared, spiralbound, 180 pages, hardback	ASTABOOE2SH	5
FOLDER, 320 x 240 mm, cardboard 250 g	ASTADIVI2C-	5
CLIPBOARD, fold over, A4	ASTAHOLD1P-	10
NOTEPAD, A4, squared	ASTANOTP2S2	5
PAD, PAPER, 90 x 90 mm, 4 colours	ASTAPADP9--	5
PEN, BALL POINT, black	ASTAPENB1B-	50
MARKER, permanent, large, chisel point, black	ASTAPENM3BB	10
RULER, 30 cm, plastic transparent	ASTARULE30-	10
PAD, INKING, refillable, red	ASTASTAM1I-	20
STAMP, DATE	ASTASTAM3D-	20
KIT GENERATOR, DIESEL, 230 V, 50Hz, 3-4 kVA	KPROKGEND3-	1
STOCK, EQUIPMENT IDENTIFICATION CARD, A4, self-copying x2	ALSTSEQI3B-	1

CABLE, EARTH, 1 cond., 6 mm ² , outdoor use (per meter)	PELECABA06-	2
(earthing cable) EARTH PIN, copper, 50 cm	PELECABAP10	1
CABLE, EXTENSION, 3 m, 4 outlets (16 A + earth), Eur plug	PELECABE03B	4
CABLE, EXTENSION, 10 m, 3 x 2.5 mm ² , Eur plug	PELECABE102	4
GENERATOR, DIESEL, 230 V, 50Hz, 3-4 kVA	PELEGEND03-	1
BOX, wooden, 740 x 733 x 860 mm	PPACBOXW7--	1
FUNNEL, WATER RETENTION FILTER, Ø 216mm, H 250mm	TVEAFUNM2--	1
JERRYCAN, 20 l, metal	TVEAJERR20M	1
OIL, ENGINE, 15W40, petrol & diesel API SJ/CF-4, 5 l, can	TVECOILE155	1
(module generator) MAINTENANCE, 1000 h, for diesel 3-4 kVA generator	KPROMMAI03D	1
▶ CARD, DIESEL MOTOR PUMP & GENERATOR FOLLOW-UP	ALSTSFUP3E-	1
▶ FILTER, AIR, adapted to the accompanying engine	PX--FILA---	5
▶ FILTER, FUEL, adapted to the accompanying engine	PX--FILF---	5
▶ STRAINER, OIL, adapted to the accompanying engine	PX--STRO---	1
MODULE, MEDICAL WASTE MANAGEMENT	KWATMWAM01-	1
MODULE PPE, medical waste management (2 operators)	KWATMPPEWM-	1
▶ MARKER, permanent, large, chisel point, black	ASTAPENM3BB	2
▶ PADLOCK, combination, 4 letters	PPACPADL4CM	2
▶ TRUNK 60 cm, aluminium, 75 l	PPACTRUN60A	2
▶ APRON, PROTECTIVE, leather, long	PSAFAPROL1-	2
▶ BOOTS, SAFETY, protective tipe, size 42, pair	PSAFBOOS42P	2





▶ BOOTS, SAFETY, protective tipe, size 44, pair	PSAFBOOS44P	2
▶ FACE SHIELD, PROTECTIVE	PSAFFACE01-	2
▶ GLOVES, HEAT RESISTANT (Sperian GBTK7065), +450°C, pair	PSAFGLOVH2-	4
▶ RESPIRATOR FFP2, disposable	PSAFMASPD2-	50
▶ OVERALL, light cotton, one size	PSAFOVER1C-	8
▶ GLOVES, PROTECTIVE, nitrile, reusable, pair, 10	SMUSGLOP10-	4
(module medical waste management) HYGIENE EQUIPMENT	KWATMWAMH1-	1
▶ POLYVIDONE IODINE, 10%, solution, 200 ml, dropper bot.	DEXTIODP1S2	2
▶ BROOM, with broomstick	PHYGBROO1-	2
▶ DUSTPAN + BRUSH	PHYGBROO2-	2
▶ BRUSH, SCRUBBING, soft bristles, with handle	PHYGBRUS4-	8
▶ GLOVES, CLEANING, rubber, reusable, pair, large	PHYGGLOC1L-	2
▶ RUBISH BIN + LID, plastic, 60 litres, tackable, blue	PHYGRUBBB60	5
▶ RUBISH BIN + LID, plastic, 60 litres, tackable, yellow	PHYGRUBBY60	15
▶ SOAP, HOUSEHOLD, liquid, 5 l tin + dosing pump	PHYGSOAPL5-	4
▶ TOWEL, 150 x 110 cm, 100% viscose	PHYGTOWE15-	8
▶ TAPE, ADHESIVE, REINFORCED, translucent, roll	PPACTAPE1R-	10
(module medical waste management) HYGIENE RTR	KWATMWAMH1D	1
▶ CHLORINE, 1 g (NaDCC / dichloroisocyan. sodium 1,67 g), tab.	DDISNADC1T-	1000

Appendix 25. Measles vaccination cards (examples)

MEASLES VACCINATION CAMPAIGN											
Last name:											
First name:											
Age:	<table border="1"><tbody><tr><td>6 - 8 months</td><td></td></tr><tr><td>9 - 11 months</td><td></td></tr><tr><td>1 - 4 years</td><td></td></tr><tr><td>5 - 9 years</td><td></td></tr><tr><td>10 - 15 years</td><td></td></tr></tbody></table>	6 - 8 months		9 - 11 months		1 - 4 years		5 - 9 years		10 - 15 years	
6 - 8 months											
9 - 11 months											
1 - 4 years											
5 - 9 years											
10 - 15 years											
Date:											

MEASLES VACCINATION CAMPAIGN	
Last and first name:	
Date of birth/age:	
Date:	

Appendix 26. Tally sheet for vaccinations and vaccine monitoring

Team:		Location:				
Date:		Site:				
District:		Region:				
Number of doses used = (nb of vials opened x nb of doses per vial)		Vaccine batch number:				
Utilization rate = $\frac{\text{Number of doses administered} \times 100}{\text{Number of doses used}} = \dots\%$						
Age group						
6 - 8 months	9 - 11 months	12 - 59 months	5 - 15 years			
○○○○○ ○○○○ ○○○○○ ○○○○ ○○○○○ ○○○○ ○○○○○ ○○○○ ○○○○○ ○○○○ ○○○○○ ○○○○ ○○○○○ ○○○○ ○○○○○ ○○○○ ○○○○○ ○○○○ ○○○○○ ○○○○ ○○○○○ ○○○○ ○○○○○ ○○○○	○○○○○ ○○○○ ○○○○○ ○○○○ ○○○○○ ○○○○ ○○○○○ ○○○○ ○○○○○ ○○○○ ○○○○○ ○○○○ ○○○○○ ○○○○ ○○○○○ ○○○○ ○○○○○ ○○○○ ○○○○○ ○○○○ ○○○○○ ○○○○ ○○○○○ ○○○○	○○○○○ ○○○○ ○○○○○ ○○○○ ○○○○○ ○○○○ ○○○○○ ○○○○ ○○○○○ ○○○○ ○○○○○ ○○○○ ○○○○○ ○○○○ ○○○○○ ○○○○ ○○○○○ ○○○○ ○○○○○ ○○○○ ○○○○○ ○○○○ ○○○○○ ○○○○	○○○○○ ○○○○ ○○○○○ ○○○○ ○○○○○ ○○○○ ○○○○○ ○○○○ ○○○○○ ○○○○ ○○○○○ ○○○○ ○○○○○ ○○○○ ○○○○○ ○○○○ ○○○○○ ○○○○ ○○○○○ ○○○○ ○○○○○ ○○○○ ○○○○○ ○○○○			
○○○○○ ○○○○ ○○○○○ ○○○○ ○○○○○ ○○○○ ○○○○○ ○○○○ ○○○○○ ○○○○ ○○○○○ ○○○○ ○○○○○ ○○○○ ○○○○○ ○○○○ ○○○○○ ○○○○ ○○○○○ ○○○○ ○○○○○ ○○○○ ○○○○○ ○○○○	○○○○○ ○○○○ ○○○○○ ○○○○ ○○○○○ ○○○○ ○○○○○ ○○○○ ○○○○○ ○○○○ ○○○○○ ○○○○ ○○○○○ ○○○○ ○○○○○ ○○○○ ○○○○○ ○○○○ ○○○○○ ○○○○ ○○○○○ ○○○○ ○○○○○ ○○○○	○○○○○ ○○○○ ○○○○○ ○○○○ ○○○○○ ○○○○ ○○○○○ ○○○○ ○○○○○ ○○○○ ○○○○○ ○○○○ ○○○○○ ○○○○ ○○○○○ ○○○○ ○○○○○ ○○○○ ○○○○○ ○○○○ ○○○○○ ○○○○ ○○○○○ ○○○○	○○○○○ ○○○○ ○○○○○ ○○○○ ○○○○○ ○○○○ ○○○○○ ○○○○ ○○○○○ ○○○○ ○○○○○ ○○○○ ○○○○○ ○○○○ ○○○○○ ○○○○ ○○○○○ ○○○○ ○○○○○ ○○○○ ○○○○○ ○○○○ ○○○○○ ○○○○			
○○○○○ ○○○○ ○○○○○ ○○○○ ○○○○○ ○○○○ ○○○○○ ○○○○ ○○○○○ ○○○○ ○○○○○ ○○○○ ○○○○○ ○○○○ ○○○○○ ○○○○ ○○○○○ ○○○○ ○○○○○ ○○○○ ○○○○○ ○○○○ ○○○○○ ○○○○	○○○○○ ○○○○ ○○○○○ ○○○○ ○○○○○ ○○○○ ○○○○○ ○○○○ ○○○○○ ○○○○ ○○○○○ ○○○○ ○○○○○ ○○○○ ○○○○○ ○○○○ ○○○○○ ○○○○ ○○○○○ ○○○○ ○○○○○ ○○○○ ○○○○○ ○○○○	○○○○○ ○○○○ ○○○○○ ○○○○ ○○○○○ ○○○○ ○○○○○ ○○○○ ○○○○○ ○○○○ ○○○○○ ○○○○ ○○○○○ ○○○○ ○○○○○ ○○○○ ○○○○○ ○○○○ ○○○○○ ○○○○ ○○○○○ ○○○○ ○○○○○ ○○○○	○○○○○ ○○○○ ○○○○○ ○○○○ ○○○○○ ○○○○ ○○○○○ ○○○○ ○○○○○ ○○○○ ○○○○○ ○○○○ ○○○○○ ○○○○ ○○○○○ ○○○○ ○○○○○ ○○○○ ○○○○○ ○○○○ ○○○○○ ○○○○ ○○○○○ ○○○○			
Total =	Total =	Total =	Total =			
Overall total =						
<small>Check one circle for each injection performed 1 large rectangle = 100 injections</small>						
Consumption monitoring	Vaccine		Supplies			
	Vaccine	Diluent	0.5 ml AD syringe	Reconstitution syringe	19G needle	Safety box
Received						
Remaining at end of day						
Vaccine vial monitors (VVM)						
Reading						
Interpretation	Use			Do not use		
Number of unusable vials:						

See [Toolbox](#)

Appendix 27. Measles vaccination summary

The Excel file **MEASLES VACCINATION SUMMARY** (iSee [Toolbox](#)) contains several worksheets, some of them protected.

This file is used to compile the data and automatically calculate the monitoring indicators for a measles vaccination campaign:

- vaccination coverage;
- syringe/safety box ratio;
- auto-disable syringe (ADS) wastage rate;
- dilution syringe/vaccine vial ratio;
- vaccine utilization rate.

Using the worksheets

- Use one file for each district. Each file includes:
 - a “District vaccination summary” worksheet;
 - a “Manual vaccination summary by location” worksheet;
 - fifteen “Summary table by location” worksheets, named A to O.
- Fill in only the yellow boxes. Do not enter data into other boxes as this may modify the automatic calculations and generate errors.

“District vaccination summary” worksheet

This worksheet is generated automatically from the Summary table by location A through O worksheets.

The worksheet is completely protected; do not enter anything on it.

It calculates the vaccination coverage for ages 9 months-15 years, 9-11 months, 12-59 months and 5-15 years.

“Manual vaccination summary by location” worksheet

This worksheet is printed out and completed each day in the field by the person in charge of the location, using the tally sheets from all of the sites in a given location.

The worksheet covers an 8-day period, but additional days can be added if the vaccination goes on longer than that.

Post-campaign catch-up activities are planned on this worksheet.

Supply consumption is completed when the campaign is over.

“Summary table by location” worksheet (A through O)

To be completed using the vaccination summary by location worksheets, which are filled in manually each day.

Use one worksheet for each area covered by a health facility. Enter the name on the tab. Start with the “Summary table by location A” worksheet and fill in the general information (country, region, district, year, target population, number of doses per vial, etc.); these will be entered automatically on the “District vaccination summary” worksheet.

The following are calculated automatically:

- the distribution, in percentage, of children 9 months to 15 years;
- the vaccination coverage by age group;
- the number of doses of vaccine used;
- the vaccine utilization rate;
- the vaccination quality and safety indicators.

Appendix 28. Calculating the number of teams needed for vaccination

The Excel file **ESTIMATING HUMAN RESOURCE NEEDS FOR VACCINATION** (see [Toolbox](#)) contains several worksheets, some of them protected.

This file is used to calculate the number of teams needed according to the data entered.

The number of core teams for vaccination depends on the size of the population to be vaccinated, the expected performance (number of vaccinations/day/vaccinator), and the desired duration of the vaccination campaign. Take into account previous experience.

Using the worksheets

- Each file has four “Zone” worksheets, named A through D. Use one worksheet for each zone covered by a health facility. If necessary, create new worksheets.
- Fill in only the yellow boxes. Do not enter data into other boxes as this may modify the automatic calculations and generate errors.

“Zone” worksheet

On each worksheet, enter:

- the name of the region, district, health care facility;
- the target population: age group and percentage;
- the name of the zone on the tab;
- for each vaccination location, indicate: the name of the location, total population, expected performance and desired duration.

The worksheet automatically calculates:

- the target population per location;
- the number of teams required per location.

If the number of teams is too large for the number of staff available, adjust the duration and/or revise performance.

Appendix 29. Vaccination team member roles

See [Toolbox](#)

Crowd control

- To inform the population: age groups targeted, vaccination site hours and number of vaccination days, availability of water.
- To organise the influx of people and the queue.
- To check the age (no vaccination before age 6 months).
- To move the people to be vaccinated toward the registrars.
- To maintain order.
- To inform the team leader in case of difficulty.

Registrar

- To prepare the equipment and supplies: table and chairs, cards, pens, date stamp and inking pad.
- To pre-stamp or write the dates on the vaccination cards, along with other necessary information (lot number).
- To ask the person accompanying the child for the information needed to fill out the vaccination card:
 - last and first name;
 - age in months (if under 1 year) or years;
 - address.
- To write legibly in pen.
- To give the card to the person accompanying the child, stressing the importance of keeping the card and presenting it at each health centre visit.
- At the end of the day: to tidy up.

Vitamin A dispenser

- To prepare the equipment and supplies: table and chair, vitamin A, needle and hand towel.
- To check the child's age to determine the appropriate dose (vaccination card):
 - Age 6 to 11 months: 4 drops from the capsule, then discard it;
 - Age 1 to 5 years: 8 drops (a whole capsule).
- To ask the person accompanying the child for help and to explain what is being administered.
- For children age 6-11 months: to take a capsule, puncture it with a needle and administer the dose.
- To make sure that the child swallows the dose (and if the child spits it out, to give another dose).
- To wash hands often.
- At the end of the day: to tidy up.

Preparer

- To give the registrars the lot number of the vaccine at the beginning of the day.
- To set up in a calm location, in the shade, near the vaccinator.
- To set up the work table with the equipment and supplies: table and chair, cold box with vaccines and diluents, vaccine carrier, injection supplies, etc.
- To prepare the sharps containers according to the procedure.
- To check the cold chain on a regular basis: cold box and vaccine carrier temperatures.
- To reconstitute the vaccine:
 - checking the vaccine name, the diluent, the expiry date, the appearance of the vaccine and diluent (colour, clarity) and the vaccine vial monitor (VVM);
 - using aseptic technique;
 - diluting only one vial of vaccine with one vial of diluent at a time;
 - storing the reconstituted vaccine in the slits in the vaccine carrier's foam pad;
 - discarding the syringe with the needle in the sharps container after reconstitution;
 - placing the used vaccine and diluent vials into separate buckets with lids.
- To fill the auto-disable syringes with the reconstituted vaccine according to the recommended procedure and then give it to the vaccinator.
- To wash hands often.
- At the end of the day:
 - to dispose of unused reconstituted vaccine, which is NEVER USED THE NEXT DAY;
 - with the vaccinator, to count the remaining supplies, vaccines and diluents;
 - to tidy up and clean the site and package the waste for transport.

Vaccinator

- To set up near the preparers, in the shade.
- To set up the equipment and check that all supplies are present: vaccine carrier, gloves, kidney dish, trash bags and sharps container.
- To wear gloves and change them regularly (every 50 vaccinations), and to wash hands with each change of gloves.
- To explain to the accompanying person how to hold the child. To ask for help, if necessary.
- To clean the injection site with cotton wool and clean water.
- To inject the vaccine in accordance with injection technique and aseptic technique.
- To discard the used syringe directly into the safety box located close by, out of the flow of people traffic. To never re-cap the needle.
- To direct the people to the recorder.
- At the end of the day:
 - to close the safety box in accordance with safety rules;
 - to count the number of vaccine and diluent vials and enter them on the tally sheet, check the VVMs and count the remaining supplies;
 - to tidy up and clean the site and package the waste for transport.

Recorder

- To set up after the vaccinator.
- To arrange the work table with the supplies: table and chair, tally sheets, pens, etc.
- To fill in the general information on the tally sheet: team, location, date, lot number, etc.
- To check the age on the vaccination card.
- To make a tick mark in the appropriate age column.
- At the end of the day:
 - to total up by age group and overall;
 - to give the tally sheet to the team leader/supervisor;
 - to tidy up.

Vaccination team leader

If there is no team leader, these duties are distributed among the team members, subject to the supervisor's approval.

The team leader is familiar with the campaign process and its practical organisation.

Every morning

- To take delivery of and verify the supplies received (quantities).
- To verify that the site is clean and well-organised:
 - there are shaded areas for waiting and the team;
 - the flow path is well-marked and each station arranged correctly.
- To make sure that everyone is at his station.
- To check that the cold chain supplies are protected from the sun.
- To designate a waste storage location, out of reach of the population.

Before the vaccination session starts

- To make sure that the crowd control people are carrying out their duties: messages to broadcast, target age group and organisation of the flow path.
- To make sure that the registrars have filled in a certain number of cards ahead of time.
- To make sure that the preparers have started reconstituting vaccine.
- To make sure that the recorder has filled in the general information on the tally sheet: team, location, date, lot number, etc.

During the vaccination session

- To ensure the smooth flow of people (no excessive waiting at each station).
- To check the quality of each person's work.
- To check the quality of the recording (reliability of the immunisation coverage calculation).
- To check the cold chain.
- In case of difficulty, to immediately inform the supervisor or the logistician, depending on the need.

At the end of the day

- To collect and check the tally sheets and calculate the coverage, the vaccine utilisation rate and the supplies used.
- To check the cold chain.
- To make sure the site is tidied up and clean.

- To check that the waste has been collected in accordance with the safety rules and given to the logistician in charge of collection.
- To review the day with the team: results obtained, strengths and difficulties, suggestions for improvement. To thank the team.
- To take stock with the supervisor: analyse and assess the day's results, corrective measures suggested and necessary means.

Appendix 30. Job description, campaign medical supervisor

See [Toolbox](#)

Works closely with the campaign's logistics supervisor.

Before the campaign

- Participates in developing the activity timetable.
- Trains and supervises the vaccination teams:
 - participates in vaccination team recruitment;
 - participates in writing job descriptions for team members;
 - participates in writing training documents;
 - participates in team member training (theoretical and practical).
- Participates in campaign organisation, planning and monitoring meetings.
- Estimates the medical supply needs for vaccination sites.
- Participates in the selection and organisation of vaccination sites.
- Oversees the organization of public information and monitors the public information messages.
- Organises and supervises the management of vaccines and medical supplies.
- Organise et supervise la gestion des vaccins et du matériel médical.

During the campaign

1. Coordination and management

- Participates in campaign coordination meetings: presents results, discusses the difficulties encountered, and shares information on how the vaccination is going.
- Participates in daily data analysis.
- Ensures rigorous management of stock movements (vaccines, traceability, medical supplies, modules and kits).

2. Vaccination sessions

- Makes sure that each person is at his station, understands his role and performs his duties according to established procedures.
- Oversees the proper organisation of the site: outside (shelter, water available, etc.) and inside (flow, circuit, etc.).
- Verifies that the crowd control team is complete and effective.
- Makes sure that those vaccinated are in the target population.
- Makes sure that vaccination cards are filled in correctly.
- Checks the temperature in the cold boxes and vaccine carriers regularly.
- Makes sure that hands are washed, gloves changed, etc. on a regular basis.
- Monitors the vaccine reconstitution and syringe preparation procedures.

- Verifies that injection safety rules are obeyed:
 - vaccinators wear latex gloves;
 - safety boxes are used correctly;
 - waste containers are stored in an isolated, protected location;
 - work-type gloves are used for handling waste;
 - waste is safely disposed of and destroyed;
 - polyvidone iodine 10% is available at every site;
 - in case of AEB: first aid given, AEB reported and person sent to the medical officer.
- Makes sure that recording is done correctly (no omissions/double entries).
- Supports the team (replacement during breaks, support in case of high volume, and support in case of difficulties).
- Identifies difficulties and institutes corrective measures.

3. At the end of the day

- Makes sure that the site is cleaned up and supplies put away.
- Collects and checks all the tally sheets (information complete and correct).
- Verifies that empty vaccine and diluent vials are gathered and counted, and that their lot number is entered on the tally sheet.
- Compiles and analyses the results.
- Completes the daily vaccination summary.
- Estimates and analyses the immunisation coverage.
- Calculates the vaccine utilisation rate.
- Fills in the vaccination summary table by location.
- Shares the results with the teams.

4. Other duties

- Participates in campaign coordination meetings: presents results, discusses the difficulties encountered, and shares information on how the vaccination is going.
- Participates in drawing up and analysing the daily summary table.

After the campaign

- Organises and supervises the inventory and storage of medical supplies.
- Participates in the final campaign evaluation and writing the final report.

Appendix 31. Job description, campaign logistics supervisor

See [Toolbox](#)

Works closely with the campaign's medical supervisor.

- Participates in developing the activity timetable.
- Trains and supervises the logistics teams:
 - Evaluates needs and participates in recruitment of logistics teams.
 - Writes the job description for members of his team (logisticians, storekeepers, security guards, drivers, technicians, etc.).
 - Participates in team training (theoretical and practical).
 - Supervises his teams' work.
- Participates in campaign organization, planning and monitoring meetings.
- Manages supply:
 - Identifies and sets up the central storehouse.
 - Organises storage and sets up management tools.
 - Evaluates needs and prepares and tracks orders.
 - Oversees stock management.
 - Coordinates equipment preparation for the sites.
 - Organizes and checks deliveries at the sites.
- Organizes and oversees the cold chain:
 - Evaluates cold chain needs and sets up the active (refrigerators and freezers) and passive (cold boxes, vaccine carriers and ice packs) cold chains.
 - Ensures the safety and reliability of electrical equipment.
 - Makes sure that equipment is operating correctly: temperature monitoring, maintenance.
 - Ensures rigorous management of the cold chain (incoming and outgoing supplies).
 - Evaluates the ice needs for the campaign and organizes ice pack freezing.
 - Organizes and monitors the cold chain at the sites.
- Coordinates the creation of vaccination sites:
 - Participates in the selection of vaccination sites.
 - Evaluates the supply/equipment needs.
 - Coordinates site set-up and organization.
 - Oversees the proper organization of the site.
 - Ensures that the sites are cleaned up at closure.
- Organizes waste collection, storage, transport and disposal:

- Visits (or selects) the central waste disposal site.
- Evaluates needs (volumes and means) and defines the collection, transport and disposal strategy.
- Supervises the set-up and operation of the central waste disposal site.
- At the vaccination sites: supervises waste collection, temporary storage, and transport to the central disposal site (or on-site waste disposal, depending on the strategy chosen).
- Makes sure that storage and/or disposal at the sites are safe: protection of sites and personnel.
- Organizes transport:
 - Evaluates needs (teams and supplies).
 - Coordinates vehicle fleet organization (number, type, schedule, personnel, etc.).
 - Organizes the staff briefing.
 - Procures and manages fuel, lubricants and spare parts.
 - Supervises vehicle maintenance.
- Organizes the communications circuit and equipment:
 - Evaluates equipment needs.
 - Organises the staff briefing.
 - Organises communications equipment management and maintenance (telephones, radios, walkie-talkies, etc.).

Other duties

- Organises and supervises the inventory and storage of materiel after the campaign.
- Participates in the final campaign evaluation and writing the final report.
- Organises safety for the logistics and medical teams: guidelines, briefing, etc.

Appendix 33. Delivery form for vaccines and vaccination supplies

Sent by: _____ Received by: _____
 Consignee: _____ Location: _____
 Date: _____ Date: _____
 Signature: _____ Signature: _____

	Quantity ^a sent	Quantity ^a received	Expiry date	Lot no. ^b	Comments
Vaccines					
Diluents					
ADS					
Syringes, 10 ml					
Needles, 19G					
Safety boxes					
Gloves					
Cotton wool					

^a Indicate the quantity in doses of vaccine and diluent.
^b Indicate the lot number for vaccines and diluents. If there is more than one lot number, use one line for each lot number.
 One copy of this document should be kept by the storekeeper and one copy given to the consignee.

See [Toolbox](#)

Appendix 34. Vaccine preparation and storage during mass vaccination campaigns

See [Toolbox](#)

The recommended methods for vaccination campaigns are different than those for routine vaccination. Staff should receive specific training prior to the campaign.

34.1 Quality of care criteria

- Aseptic technique is used when reconstituting vaccine and preparing syringes.
- The dose prepared in the auto-disable syringe (ADS) is the correct dose for administration.
- The temperature and time limits (6 hours) for reconstituted vaccine storage are respected.
- Sharps are collected and safely transported in special safety boxes (sharps containers).

34.2 Supplies/equipment needed for vaccine preparation

- Vials of vaccine (lyophilised powder) and vials/ampoules of diluent
- Hand hygiene supplies (soap, bowl, hand towel and water) or alcohol-based solution
- Pliers or scissors for removing the protective cap from vials or a file for ampoules
- Sterile 5-, 10- or 20-ml syringes (depending on the volume of diluent) and sterile 19g (cream colour) needles for reconstituting the vaccine
- Sterile 0.5-ml ADS
- Clean tray
- Safety boxes for collection, transport and disposal of sharps
- Cotton wool

34.3 Cold chain for storing vaccines

Vaccines must be kept between +2 and +8 °C throughout the entire chain (storage at the site and holding vials after reconstitution).

The equipment for the site varies with the number of teams^a :

1 vaccination team	2 vaccination teams
1 RCW25 Electrolux [®] cold box + thermometer 1 giostyle [®] vaccine carrier	1 RCW25 Electrolux [®] cold box + thermometer 2 giostyle [®] vaccine carriers

The **cold box** can be used to store vaccines and diluent for one or two teams at one site. The volume per dose (vaccine and diluent) varies, depending on manufacturers. For example, if the volume is 3 cm³/dose, 3,000 doses of vaccine and diluent can be stored on each site. Check before the beginning of vaccination session.

To minimise the risk of freezing or breakage:

- Leave the ice packs at room temperature for at least 30 minutes before placing them in the cold box. The ice packs are ready when the frost on the outside has melted and the ice inside has begun to melt (there is a little water inside the pack).
- Leave the vaccine vials in their box so that they do not come in direct contact with the ice packs.

Monitor the temperature (thermometer/VVM).

The **vaccine carrier** (one per team) is used by the two preparers.

It is used for intermediate storage. Small amounts of vaccine and diluent are taken out of the cold box as needed to limit how often the cold box is opened.

Vials of reconstituted vaccine are placed in the slits in the foam pad in the vaccine carrier lid.

See the illustration below.



- A. Cold box
- B. Vaccine carrier
- C. Syringes
- D. needles
- E. Safety boxes
- F. bins

The number of **ice packs^b** in each cold box and vaccine carrier will depend on the outside temperature:

	Electrolux® RCW25 cold box	Giostyle® vaccine carrier
Ice packs	0.6-litre	0.4-litre
If outside $T^{\circ} \leq 40^{\circ}C$	12 to store the vaccines for 2 days 14 to store the vaccines for 3 days	6 per vaccine carrier, replace daily
If outside $T^{\circ} > 40^{\circ}C$	18 to store the vaccines for 2 days 24 to store the vaccines for 3 days	8 per vaccine carrier, replace daily

- Cold boxes and vaccine carriers should be clean and dry.
- To reduce the risk of the vaccines freezing, ice packs should be left out for at least 30 minutes at room temperature until the ice begins to melt (water forms; check by shaking them) before being placed into cold boxes.
- Wipe and dry the ice packs before placing them in cold boxes and vaccine carriers.
- keep the vaccine vials in their box or in a plastic bag to prevent the labels from peeling off (from the moisture).

The **vaccine vial monitor** affixed to each vaccine vial allows verification that the vaccine has not been damaged by heat. When the vial is exposed to heat, the square inside the circle darkens. Only use vials whose squares are lighter than the surrounding circles:

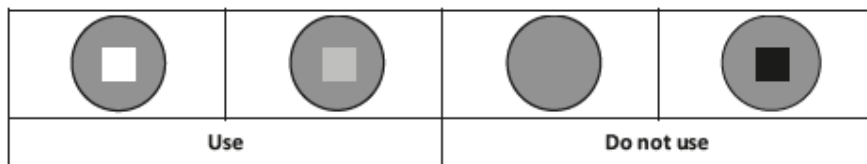

34.4 Reconstituting the vaccine

- Wash hands or disinfect them with an alcohol-based solution. Preparers do not need to wear gloves.
 - Take one vial of vaccine and one vial of diluent from the vaccine carrier.
 - Check:
 - the name of the vaccine;
 - the name of the diluent, and that each diluent corresponds to a vaccine (same manufacturer);
 - the expiry date;
 - the appearance of the lyophilised powder and the diluent (colour and clarity);
 - the vaccine vial monitor (VVM).
 - Tap the vial or ampoule of vaccine so that the powder settles.
1. Open the vial or ampoule:
 - for a vial, remove the protective cap:
 - pre-scored metal cap: remove with pliers;

- plastic cap: pop it off with thumb.

For an ampoule, carefully break off the end while holding the ampoule with clean cotton wool.

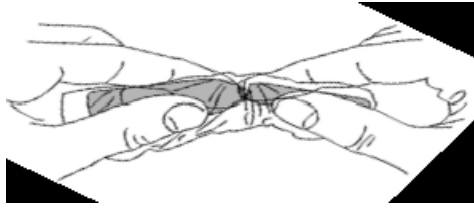

2. Fit the 19G needle onto the syringe.

Withdraw the recommended amount of diluent (see the package insert).

Insert the needle into the vaccine vial and gently inject the diluent. Remove the syringe and needle together and discard them in the sharps container without recapping the needle.



3. Roll the vial between the palms to thoroughly dissolve the powder.

Check the appearance (colour and clarity) and make sure there are no crystals. If in doubt, do not administer the vaccine and consult the appropriate person.



4. Store the reconstituted vaccine in the slits in the vaccine carrier's foam pad (the vaccine is heat-sensitive).

Each preparer reconstitutes only one vial at a time and then fills the syringes.

Do not reconstitute a large number of vaccine vials that may not be used.

Without replacing the ice packs, vaccine carriers left open for 8 hours at an average ambient temperature:

- of 25 °C will maintain an average internal temperature of 4 °C;
- of 31 °C will maintain an average internal temperature of 7 °C.

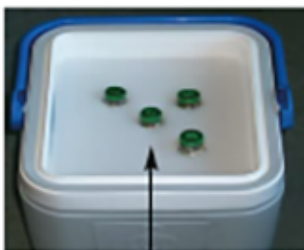

Vials inserted
in slits in the
foam

Summary

- When using a lyophilised vaccine for the first time: read the package insert.
- Diluents are not interchangeable. Each manufacturer supplies a specific diluent (composition) for each type of lyophilised vaccine.
- Diluents must be refrigerated for at least 12 hours before reconstitution so that they are at the same temperature as the vaccine at the time of preparation (between +2 and +8 °C).
- All reconstituted vaccine should be stored between +2 and +8 °C and discarded after 6 hours.
- use one reconstitution syringe and needle per vial. Do not re-use them to reconstitute other vials.
- In case of an accidental cut when opening an ampoule, there is a risk of vaccine contamination. Discard the ampoule, cover the wound with a dressing and put on gloves.
- Do not touch the needle or the end of the syringe.
- Never re-cap needles.

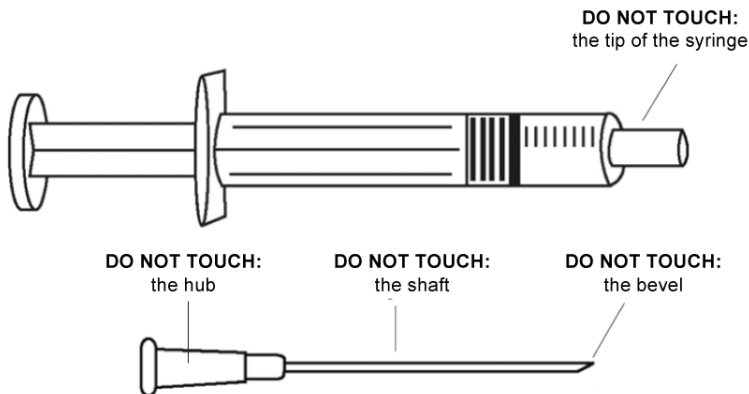

34.5 Preparing auto-disable syringes (ADS) for vaccine administration

- Do not remove syringes from their packaging in advance.
- Stick the ADS needle perpendicularly into the vial stopper.
- Invert the vial and hold it straight up and down.
- keep the point of the needle below the fluid level of the vaccine.
- Draw exactly 0.5 ml into the ADS.
- Remove the ADS from the vial.
- Purge any air by tapping the ADS, holding it vertically with the needle pointing up. A drop of vaccine should appear at the bevel of the needle.
- Check to make sure that the ADS contains 0.5 ml of vaccine. Do not use an ADS containing less than 0.5 ml.

Note: a 10-dose vial holds enough to fill ten 0.5 ml ADS. If the last syringe is not completely filled, add vaccine from another vial.

In case of accidental needle stick when handling the prepared ADS: DO NOT USE, discard immediately in the safety box.

34.6 Using prepared syringes

Give the prepared ADS directly to the vaccinator.

Prepare the syringes a few at a time, depending on the flow of people to vaccinate.

When the flow is heavy (e.g., urban areas, IDP camps or schools) or early in the day, syringes are prepared at a sustained pace. Good coordination between the preparers and the vaccinator is needed to prevent mishaps.

Vials containing leftover doses at the end of a session are collected and destroyed.

All vaccine and diluent vials are collected and counted for monitoring.

34.7 Using the safety box

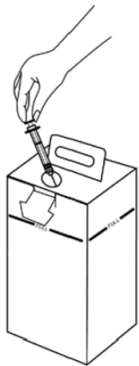

- All used sharps are discarded in a safety box immediately after use.
- If possible, use 15-litre safety boxes for vaccination campaigns^c.
- Do not go beyond the safety box's maximum syringe capacity. Do not fill beyond the maximum line shown.
- Do not handle the safety boxes unnecessarily, shake them, or compress them.
- Store them in a safe place, out of reach of the public, while they wait to be transported for disposal.
- The personnel that handle the safety boxes should always wear thick gloves (at the vaccination site, during transport to the disposal site and at the disposal site).
- They should never be carried in someone's arms.

Footnotes

- (a) In densely-populated areas, a vaccination site can accommodate one or two teams, at most. With more than two teams, the crowd is too large. It is better to open second site. Ideally, two teams per site rationalises the logistical resources and supervision.
- (b) Note: sometimes the number of ice packs is less than that recommended by the manufacturer, but enough to keep the vaccine at the recommended temperature (as long as there is still ice in the ice packs). This reduces the number of ice packs needed.
- (c) There are 5-, 10- and 15-litre safety boxes that can hold 100, 200 and 400 syringes, respectively.

Appendix 35. Vaccination team observation/ supervision grid

See [Toolbox](#)

Date: _____	Name: _____
Location/site: _____	Team: _____

Write any additional comments or information at the end of this document.

	YES	NO
Information and social mobilisation		
The site is clearly identified (banner, other).		
Informational messages are announced regularly at the site: vaccine, target, vaccination card, duration, etc. (megaphone, other).		
The registrars inform the people accompanying children about the vaccination, including potential adverse effects and what to do about them.		
After recording, the people accompanying children are informed of the importance of routine immunisation follow-up (EPI target groups).		
The population covered by the site knows the target population, the vaccine and the dates of the campaign.		
Vaccination site organisation		
The site is well laid-out with organised queues and smooth traffic flow.		
The flow path is logical (sorting, information, registration, vaccination and recording).		
Equipment is out of the public's reach.		
The vaccination team is complete.		
Availability of vaccines, renewable supplies and equipment		
There is a full complement of equipment (tables, chairs, benches, etc.).		
The injection supplies and vaccines received are counted and the information copied onto the tally sheet at the beginning of the day.		
The <i>Equipment for one vaccination team</i> module is complete.		
There are enough vaccine doses for the day.		
The amounts of vaccine and diluent in the cold box match up.		
There are corresponding quantities of injection supplies available (reconstitution		

syringes and needles, ADSs and sharps containers).		
Quality of activities		
1. Cold chain		
There is a full complement of cold chain equipment (1 cold box + thermometer, 1 vaccine carrier).		
The number of ice packs is the recommended amount.		
The storage temperature is appropriate.		
There are no vaccines whose VVM indicates heat damage (otherwise, specify how many).		
2. Vaccine reconstitution		
Vaccines and diluents are checked (name, expiry date, appearance, VVM).		
The diluent used corresponds to the vaccine (supplied by the same manufacturer).		
Vaccines and diluents are the same temperature at the time of reconstitution (between +2 and +8 °C).		
Reconstitution is performed with ONE syringe and ONE needle for each vial.		
After each vial is reconstituted, the injection supplies are discarded in the safety box.		
The vial of reconstituted vaccine is stored in the slit in the vaccine carrier's foam pad.		
3. Syringe (ADS) preparation		
Aseptic technique is followed.		
The syringes are purged.		
The syringes contain exactly 0.5 ml.		
The prepared syringes are given directly to the vaccinator.		
The pace of preparation is appropriate to the flow of people to be vaccinated.		

The team is well-organised (see diagram); preparer/vaccinator coordination is good.		
Unused vials of reconstituted vaccine are disposed of at the end of the day.		
4. Use of safety boxes		
All reconstitution syringes/needles and ADSs are thrown into safety boxes immediately after use, without recapping.		
The quantity of syringes disposed of in the safety box does not exceed the fill limit.		
The full safety boxes are stored in an area out of the public's reach.		
5. Waste transport		
Waste is transported to the storage and disposal site at the end of the day.		
The person who transports the waste to the disposal area wears thick gloves.		
Registration and data collection		
General information (team, location, date, etc.) on the tally sheet is complete.		
Everyone vaccinated is tallied correctly in their age group.		
Totals are done and calculations checked at the end of the day.		
Supplies are counted and the status of the VVMs copied onto the tally sheet.		
Site closure		
Tally sheets are collected and verified (total vaccinations, vaccines and utilisation rate, VVM status and injection supplies).		
The site is tidied up and cleaned by the team.		
The waste is packaged for transport and stored in a protected area.		
There is a quick assessment of the day with the team at the site (results shared, difficulties encountered, things to improve, solutions, thanks for the work done).		

Comments:

Appendix 36. Vaccination site organisation

Area	Location		Equipment	Staff	Duties
	Waiting	Spacious, shaded area	<ul style="list-style-type: none"> For shade: tarps, shade cloth Drinking water and cups Megaphone + batteries 	<ul style="list-style-type: none"> Volunteers 	<p>Informing the population (age group targeted by the vaccination).</p> <ul style="list-style-type: none"> Organizing the queues. Maintaining order.
Sorting	When joining the queue		<ul style="list-style-type: none"> Ropes/barrier tape Stakes 		<ul style="list-style-type: none"> Verifying children's ages according to the target population. Organizing the queues and explaining the path to follow.
Registration	At the entrance to the site; spacious, sheltered area		<ul style="list-style-type: none"> Tables and chairs Vaccination cards Pens and date stamps 	<ul style="list-style-type: none"> People who can read and write (teachers, administrative staff) 	<ul style="list-style-type: none"> Filling out the vaccination cards. Explaining the card's importance. Answering any questions
Vitamin A	After registration		<ul style="list-style-type: none"> 200,000 IU retinol capsules 	<ul style="list-style-type: none"> Volunteer 	<ul style="list-style-type: none"> Administering the age-appropriate dose.
Vaccination	After vitamin A distribution		<ul style="list-style-type: none"> Tables and chairs Water, soap, hand towel (handwashing) 	<ul style="list-style-type: none"> Nurses Student nurses Midwives Health workers 	<ul style="list-style-type: none"> Cleaning the skin with water. Vaccinating.
Preparation	Calm area away from		<ul style="list-style-type: none"> Sharps container, 		<ul style="list-style-type: none"> Checking the vaccines and

	the circuit and near the vaccinator		<p>trash bags</p> <ul style="list-style-type: none"> • Injection supplies, cotton wool, scissors, kidney dish, water • Vaccine carrier • Cold box (vaccines and diluents) 	trained in vaccination	<p>diluents (expiry date, name of vaccine, appearance).</p> <ul style="list-style-type: none"> • Reconstituting the vaccines. • Keeping the reconstituted vaccines in the cold chain (vaccine carrier foam pad). • Preparing the ADSs and giving them directly to the vaccinator.
Storage	Close to the preparers Secure, shaded area		<ul style="list-style-type: none"> • For shade: tarps, shade cloth (if outdoor site) • Injection supplies (syringes, gloves, etc.) • Cold chain (storage, transport) • Safety boxes, trash bags • Water 	<ul style="list-style-type: none"> • Logistics officer 	<ul style="list-style-type: none"> • Managing the stock (vaccines, injection supplies, etc.) and supply. • Watching over the cold chain.
Waste storage	Secure area		<ul style="list-style-type: none"> • Work gloves 		<ul style="list-style-type: none"> • Gathering safety boxes/bins.
Recording	At the point of exit, near the vaccinators		<ul style="list-style-type: none"> • Tables and chairs • Clipboard, tally sheets 	<ul style="list-style-type: none"> • People who can read and write (teachers, 	<ul style="list-style-type: none"> • Filling in the tally sheet. • Directing vaccinated

			and pens	administrative staff)	people toward the exit.
--	--	--	----------	--------------------------	----------------------------

Appendix 37. Module equipment for one vaccination team

See [Toolbox](#)

	Quantity	Use
PASSIVE COLD CHAIN		
VACCINE CARRIER, 2.6 l (GioStyle®) + 8 ice packs 0.4 l	1	
COLD BOX, 20.7 l Electrolux RCW 25/Cf + ice packs 0.6 l + 1 thermometer	1	
VACCINES AND RENEWABLE MEDICAL EQUIPMENT^a (to be completed each day when the team gets back)		
VACCINES and DILUENTS (nb of doses according to expected performances + buffer stock)	1500	
COTTON WOOL, hydrophilic, roll, 500 g	2	
SAFETY BOX, 15 l, cardboard for incineration	5	Collection of syringes and needles
NEEDLE, s.u., Luer, 19g (1.1 x 40 mm), cream IV	160	Reconstitution of vaccines
SYRINGE, s.u., Luer, 5 or 10 ml (according to the volume of diluent/ampoule)	160	Reconstitution of vaccines
SYRINGE, AUTO-DISABLE, s.u., 0.5 ml	1600	Administration of vaccines
GLOVES, EXAMINATION, latex, s.u. non sterile, medium	20	Protection for vaccinators
VACCINATION CARD	1500	
TALLY SHEET	6	
RETINOL, 200,000 lu capsule (vitamin A)	1500	
BAG, REFUSE, 100 litres	5	Collection of soft waste (packaging, cotton, etc.)
MEDICAL EQUIPMENT and LOGISTIC EQUIPMENT (to be given to team leaders on the first day)		

MEDICAL		
COAT, MEDICAL, 1 for each vaccinator and preparer	3	
KIT EPINEPHRINE (1 ampoule of 1 mg/ml + 1 syringe 1 ml + 1 needle IM + protocol)	1	
KIDNEY DISH, small bowl for cotton	1	For soaking cotton pads
JERRYCAN, 20 l, with tap	2	Drinking water and handwashing
SOAP, 200 g, bar	1	Handwashing
BRUSH, nail scrubbing, plastic	1	
PAPER, KITCHEN, roll	2	
POLYVIDONE IODINE, 10%, solution, 200 ml bottle	1	Disinfection in case of AEB
CUP, 250 ml, plastic	2	
SPONGE	1	Cleaning of tables and equipment
SCISSORS	1	For removing the caps from bottles, etc.
BUCKET + LID, 4 l, plastic	2	Collection of vaccine and diluent vials for counting and transportation to waste areas
STATIONERY		
STAMP, DATE and INK PAD	2	For filling out vaccination cards
FOLDER, cardboard	1	For keeping tally sheets
CLIPBOARD, fold over, A4 (tally sheet)	1	For the recorder
PEN, BALL POINT, black	5	For the recorder and registrars (card)
MARKER, permanent, large, black	1	

NOTEBOOK, A4	1	
LOGISTIC EQUIPMENT		
TAPE, adhesive, PVC (roll)	1	
GLOVES, HEAVY DUTY, with leather protection, pair	1	Waste handling
TAPE, BOUNDARY MARKING, white/orange, fluo., 500 m roll and/or ROPE 20 mm	1	Boundary of the site and the circuit
MEGAPHONE, 6 W min., battery powered	1	Information on the site and/or area
BATTERY, 1.2 V, R6 (AA)	8	

Footnotes

(a) If necessary, add other items according to the related activities (deworming, MUAC, etc.).

Appendix 38. Module equipment for one supervision team

See [Toolbox](#)

	Quantity
PASSIVE COLD CHAIN	
COLD BOX, 20.7 l Electrolux RCW 25/Cf + ice packs 0.6 l + 1 thermometer	1
VACCINES AND RENEWABLE MEDICAL EQUIPMENT^a (to be completed each day when the team gets back)	
VACCINES and DILUENTS (doses)	1000
COTTON WOOL, hydrophillic, roll,	2
SAFETY BOX, 15 l, cardboard for incineration	4
NEEDLE, s.u., Luer, 19g (1.1 x 40 mm), cream IV	100
SYRINGE, s.u., Luer, 5 or 10 ml (according to the volume of diluent/ampoule)	100
SYRINGE, AUTO-DISABLE, s.u., vacci., 0.5 ml	600
GLOVES, EXAMINATION, latex, s.u. non sterile, medium	100
VACCINATION CARD	1000
TALLY SHEET	10
RETINOL, 200,000 lu capsule (vitamin A)	1000
BAG, REFUSE, 100 litres	10
MEDICAL EQUIPMENT and LOGISTIC EQUIPMENT	
KIT EPINEPHRINE (1 ampoule of 1 mg/ml + 1 syringe of 1 ml graduated in 0,01 ml + 1 needle IM + protocol)	1
SOAP, 200 g, bar	2
POLYVIDONE IODINE, 10%, solution, 200 ml bottle	1
SCISSORS	1

STATIONERY	
FOLDER, cardboard	1
PEN, BALL POINT, black	5
MARKER, permanent, large, black	1
NOTEBOOK, A4	1
OTHER SHEETS (supervision, AEFI, others)	
LOGISTIC EQUIPMENT	
TAPE, adhesive, PVC (roll)	2
GLOVES, HEAVY DUTY, with leather protection, pair	1
TAPE, BOUNDARY MARKING, white/orange, fluo., 500 m roll and/or ROPE 20 mm	1
BATTERY, 1.2 V, R6 (AA)	12

Footnotes

(a) If necessary, add other items according to the related activities (deworming, MUAC, etc.).

Appendix 39. Monitoring distribution and consumption of vaccines and medical supplies

The Excel file **MONITORING DISTRIBUTION AND CONSUMPTION OF VACCINES AND MEDICAL SUPPLIES** (see [Toolbox](#)) contains several worksheets, some of them protected. This file is used to estimate vaccine needs and monitor the consumption of supplies during the vaccination campaign.

Using the worksheets

- Use one file for each region or district. Each file includes:
 - one “Assessment of needs by vaccination location” worksheet;
 - fifteen “Tracking supply team” worksheets, named A through O.
- Fill in only the yellow boxes. Do not enter data into other boxes as this may modify the automatic calculations and generate errors.

“Assessment of needs by vaccination location” worksheet

- When using for the first time, indicate:
 - the name of the region and district;
 - the age group of the target population;
 - the target population as a percentage of the total population;
 - the volume of one dose of vaccine in cm^3 ;
 - the number of doses per vial;
 - the name of each vaccination location, specifying: the total population and the population already vaccinated on previous days.
- The worksheet automatically calculates:
 - *For each location:*
 - the target population (number of inhabitants);
 - the population to be vaccinated = target population – population already vaccinated;
 - the number of doses of vaccine required (including losses);
 - the volume of the vaccines (in litres);
 - the number of auto-disable syringes, syringes and needles for dilution, safety boxes, gloves and cotton required;
 - the number of “Renewable medical supplies” modules required.
 - *For all locations:*
 - the total of the different items.

“Monitoring supply and consumption by location/vaccination team” worksheet

- When supplying for the first time, enter:
 - the name of the district, the location, the site and the team;
 - the date;
 - the quantities of modules given: Equipment and Renewable medical supplies.
- Every day:
 - enter the quantities delivered (only for renewable supplies), if applicable.
- When vaccination in the location is over or when closing the vaccination site:
 - enter the total leftover supplies recovered.

The worksheet automatically calculates:

- the total given;
- the quantities used.

Appendix 40. Vehicle and fuel monitoring

See [Toolbox](#)

Vehicle tracking/assignment

Vehicle identification ^(a)	Vehicle source ^(b)	Name of driver ^(c)	Telephone	Assignment	
				Location	Team

- (a) Each vehicle is assigned an ID number. This number should be clearly displayed on the vehicle.
- (b) for rental vehicles, indicate the beginning and end dates of the rental contract.
- (c) Drivers are assigned to the same vehicle for the duration of the campaign.

Fuel consumption

Vehicule identification:			Fuel type:	
Date	Mileage	Number of litres	Amount	Name and signature of driver

Appendix 41. Cold chain monitoring tools

Successive temperature fluctuations can reduce the efficacy of the vaccine. It must therefore be kept at a constant temperature between 2 °C and 8 °C (or according to the manufacturer's recommendations) from production to administration.

Rigorous temperature monitoring is critical for detecting any breaks in the cold chain:

- International transport: temperature recorder, cold chain monitoring card;
- Refrigerator: thermometer, temperature monitoring sheet and Stop!Watch® card;
- Transport to the vaccination site: thermometer;
- Vaccines: vaccine vial monitor (VVM).

Any cold chain problems should be noted and reported to the person in charge so that a decision can be made on whether to use the vaccines.

41.1 Stop!Watch® card with Freeze-tag®

This card is equipped with irreversible temperature monitor and freeze indicators. It is used to verify the temperature inside a refrigerator.

Place the card in the refrigerator 60 minutes before activating it by pulling the tab.

It should remain in the refrigerator at all times.

The Stop!Watch® card is a supplementary monitor that does not eliminate the need to fill in the temperature monitoring sheet 2 times daily.

- A **heat-sensitive indicator** with four windows (A, B, C, D):
 - Windows A, B and C turn gradually and irreversibly blue when the indicator is exposed to temperatures above 10 °C, as a function of the exposure duration and temperatures.
 - Window D turns blue within 2 hours when the indicator is exposed to temperatures above 34 °C.



On the front of the card, write:

- the date it was put in service;
- the name of the storehouse;
- the status of the freeze indicator;
- the date on which a window (A, B, C or D) turned blue.

On the back of the card, write:

- the inspection date;
- the status of the indices (A, B, C or D);
- the status of the freeze indicator;
- the supervisor's name.

- **A freeze indicator (Freeze-tag®):**



When the indicator is exposed to a temperature of 0 °C for more than 1 hour, the screen changes from “OK” to “ALARM”.

Any colour change or triggering of the freeze indicator should be noted on the back of the card.

41.2 Vaccine vial monitor

A dot that changes colour (darkens) irreversibly when the vaccine is exposed to heat for a given amount of time. The dot is applied to the cap or label of the vaccine vial or ampoule.

All vials for which the square is lighter than the surrounding disk can be used; however, vials whose square has begun to change colour should be used first.

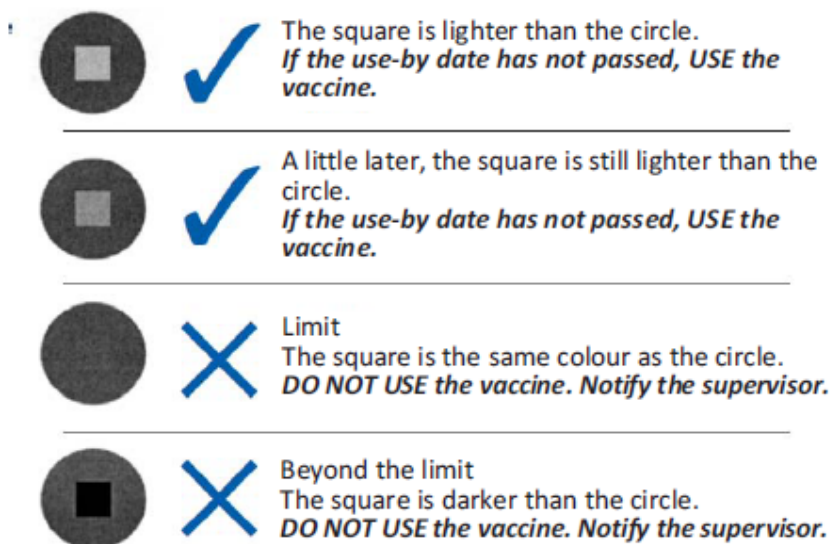

Appendix 42. Cold chain failure report

See [Toolbox](#)

Name and position of person reporting: _____

District/region: _____

Incident date and location: _____

Refrigerator type: _____

Incident summary (circumstances, source of the problem, temperature noted, times, etc.):

Actions taken to fix the problem:

List of products and information:

Item code	Item	Manufacturer	Lot no.	Quantity	Price /unit	Total value	Stop!Watch [®] information	Instructions for use

Appendix 43. Severe allergic reaction to a vaccine

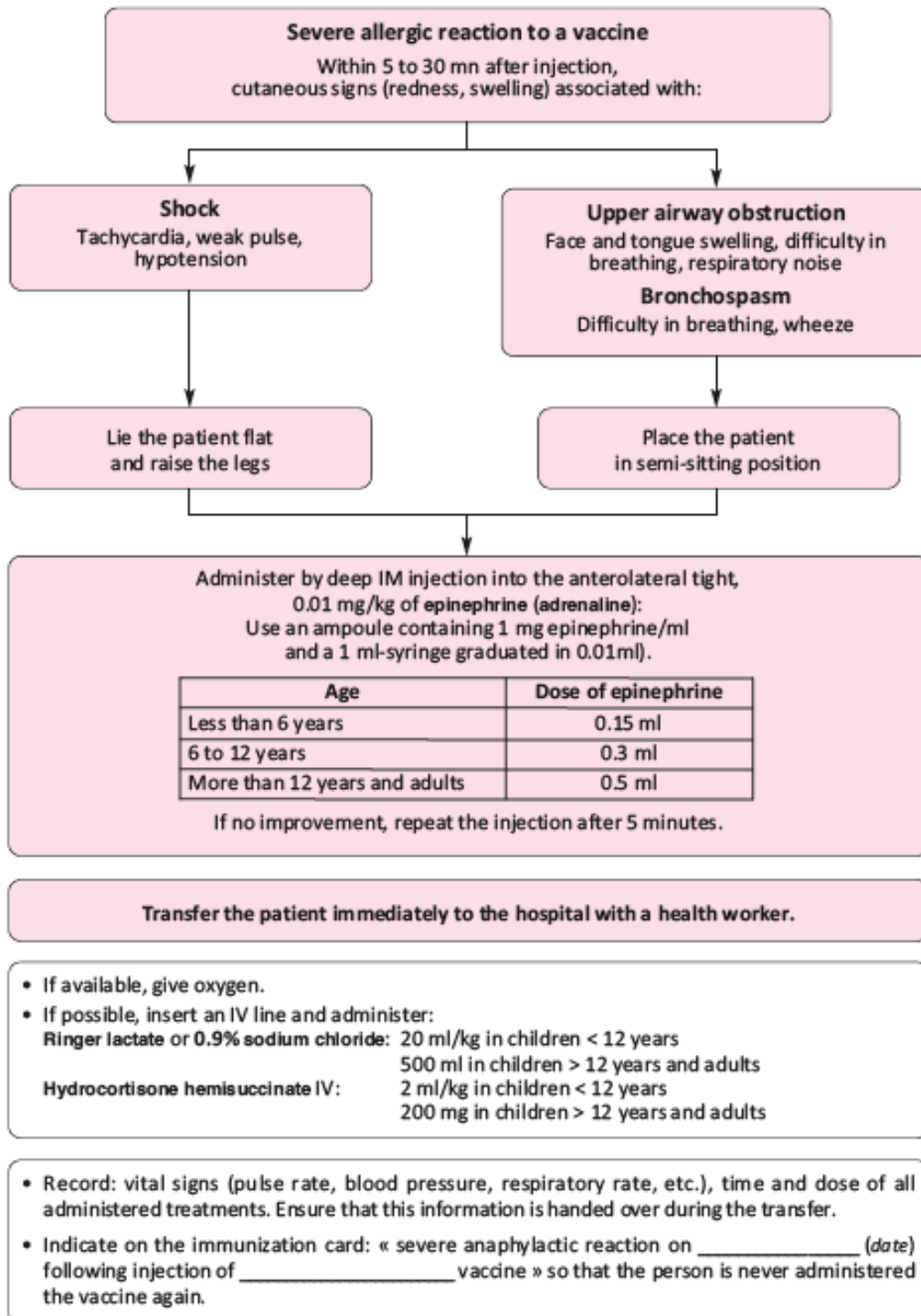

Appendix 44. Individual notification form for AEFI with measles vaccine

Province: _____ Patient's last name: _____
District: _____ Patient's first name: _____
Health facility/site: _____ Address and contact (tel, mail): _____
If hospital, indicate the unit/ward: _____
Name of notifying person: _____
Date of notification: _____ Age (months/years): _____

Information on immunisation

Vaccination card: Yes No (if no, indicate the source of information):

Place vaccine administered (village, vaccination site):

Date vaccine administered:

Route of administration: SC IM

Injection site: Arm Thigh Other (specify):

	Manufacturer	Batch number	Expiry date
Vaccine			
Diluent			

Total number of vaccinated children (same day, same place):

Adverse events following immunization

Date onset of adverse event:

History of allergy: No Yes (specify):

Time interval between vaccine administration and onset of reaction:

Type of reaction (specify):

- Fever: No Yes (specify T°):
 - Skin eruption: No Yes (indicate location):
 - Local reaction at injection site: No Yes (specify: pain, redness, infection, other):
 - Swelling, oedema: No Yes (indicate location):
 - Other (specify: anaphylactic reaction, neurologic events, etc.):
-

Management and outcome

Treatment received (drugs and doses):

Hospitalised: No Yes (indicate duration):

- Outcome: Fully recovered
 Sequelae (specify):
 Death (specify date and cause):
 Unknown (lost to follow-up)
 Other (specify):

See [Toolbox](#)

Appendix 46. Accidental exposure to blood (AEB) during a vaccination campaign

46.1 First aid

In case of a needle stick or a cut with blood-contaminated materials (percutaneous exposure):

- let the wound bleed;
- clean the wound and the surrounding skin immediately with soap and water, and then rinse;
- disinfect with polyvidone iodine 10% for 5 minutes.

46.2 Evaluating the risk of transmission

The average seroconversion rate with percutaneous exposure is 0.3% for HIV and 10-30% for hepatitis B.

The actual transmission risk depends on the amount of infected blood transmitted and the source patient's viral load. Wearing gloves probably reduces the risk greatly.

During vaccination campaigns, the most common accidents are needle stick injuries with a needle used for IM or SC injection. The risk is considered "intermediate".

For an AEB with materials used more than 72 hours previously, the risk of infection is extremely low for HIV, but remains significant for hepatitis B.

46.3 Decision to treat

A medical focal person is responsible for analysing the risk, providing psychological support to the person exposed and choosing a course of action.

The risk analysis should be done quickly so that prophylaxis, if necessary, can be started as soon as possible. The analysis should be painstaking in order to clearly determine whether or not antiretroviral prophylaxis is indicated.

The type of exposure, the source patient's serological status and the status of the person exposed (for HBV) should be taken into account when deciding what to do.

Post-AEB prophylaxis in an intermediate exposure context:

HIV		
Status of source patient (test or clinical history)	Positive	Prophylaxis recommended
	Negative	No prophylaxis
	Unknown	No prophylaxis ^(a)
Hepatitis B		
Status of the person exposed	Full immunisation < 5 years ago	No booster
	Immunisation incomplete or > 5 years ago	One booster
	No immunisation	Rapid hepatitis B immunisation schedule

(a) The risk-benefit trade-off is not in favour of starting prophylaxis, except in specific situations that should be evaluated after consultation with a specialist.

Antiretroviral prophylaxis should ideally begin within 4 hours of the AEB, and within 72 hours at the latest. The total duration of treatment is 4 weeks.

46.4 Reporting the AEB and monitoring the person exposed

Confidentiality is a must, even in emergency or difficult situations.

After local first aid, the accident must be reported to the medical officer, whether post-AEB prophylaxis is prescribed or not.

An individual AEB reporting form (with the name of the person exposed) is used to describe the AEB and its management. This confidential form must be completed by the doctor.

Medical follow-up is compulsory, whether post-AEB prophylaxis is prescribed or not.

Clinical monitoring

- Look for possible signs of seroconversion.
- Monitor for tolerance to the prophylactic treatment, if prescribed; look for and manage adverse effects, provide support to encourage good treatment adherence.
- Provide support for the person exposed: reassure (exposure can be a source of worry) and encourage adherence.

Laboratory monitoring

- Perform antibody testing for HIV, HBV and HCV within 8 days of the AEB. If positive, the accident was not the cause of the seroconversion; if at least one of the tests is positive, refer for specialised follow-up.
- If HIV-negative, HBV-negative and HCV-negative, follow this schedule:

	People receiving AEB prophylaxis	People not receiving AEB prophylaxis
Between Day 0 and Day 8	HIV, HBV ^(b) , HCV ^(c) Creatinine clearance if tenofovir	HIV, HBV, HCV
Day 15 (or sooner if clinically indicated)	Hb ^(d) ALT ^(e) Creatinine clearance if tenofovir	
Month 1 (or sooner if clinically indicated)	HIV Hb ALT Creatinine clearance if tenofovir	HIV
Month 3	HIV, HBV, HCV ALT	HIV, HBV, HCV ALT
Month 6	HIV, HBV, HCV ALT	HIV, HBV, HCV ALT

(b) Hepatitis B virus

(c) Hepatitis C virus

(d) Haemoglobin

(e) Alanine amino transferase

46.5 AEB kit

AEB kits contain a complete antiretroviral treatment (28 days) for one person.

The kit below contains a triple therapy regimen (zidovudine/lamivudine + lopinavir/ritonavir), but kit contents may vary depending on the national recommendations.

KMEDMPEP01- List of items	Code	Qty
LPV 200 mg/r 50 mg, tablet	DORALPRF2T5	120
AZT 300 mg/3TC 150 mg, tablet	DORAYILA3T1	60
Procedure to be followed in case of accidental exposure to blood	L028AIDG02EF	1

Appendix 47. Reporting form for AEB during a vaccination campaign

Confidential form to be completed by the doctor treating the person exposed, in duplicate (one copy for the person exposed and one copy for the reporting doctor).

See [Toolbox](#)

Person exposed

Last and first name: _____

Date of birth: _____

Address and contact: _____

Description of the AEB

Place where AEB occurred: _____

Date: _____ Time: _____

Type of contact (*needle stick, other*):

Circumstances of the AEB:

Description of the injury (*e.g., single stick, multiple sticks*):

In case of accident with a needle, specify the size of the needle: _____

At the time of the accident:

Wearing gloves? Yes No
(*If yes, specify: latex, work gloves*) _____

Wearing protective glasses? Yes No

Status of the source person

Person known? Yes No

Serological status known? Yes No

If yes, results: Negative Positive

If no, result of medical evaluation:

Management

First aid (*specify*): _____

Prophylactic treatment:

Offered? Yes No

Prescribed? Yes No

If no, give the reason: _____

Time between the AEB and start of treatment:

< 4 hours 4 to 24 hours > 24 hours ≤ 72 hours

Other (*specify*): _____

Drug(s) prescribed and dosage (*give the name and dosage of each drug, and duration*):

Laboratory monitoring

Can the following tests be done within 8 days of the exposure?

HIV test Yes No

HCV test Yes No

HBV test Yes No

If no, give the reason: _____

Comments

Is the person exposed on disability leave? Yes (*specify the duration*) _____
 No

Reporting date and location: _____

Name and signature of reporting doctor: _____

Toolbox

- [2. Register of measles samples](#)
- [3. Request form for laboratory diagnosis of measles](#)
- [5. Register of measles cases](#)
- [6. Measles surveillance](#)
- [8. Measles inpatient unit organization-example](#)
- [9. Estimating needs - Measles treatments](#)
- [10. Donation form - examples](#)
- [11. Treatment availability monitoring](#)
- [13. Case management](#)
- [14. Plan rehydration WHO](#)
- [17. Example of vaccination campaign timetable](#)
- [18. Estimating needs - Vaccines and injection supplies](#)
- [20. Cold chain evaluation/inventory](#)
- [21. Cold chain equipment technical sheets](#)
- [22. Temperature monitoring form](#)
- [23. Estimating needs - Freezing capacity for a vaccination campaign](#)
- [26. Tally sheet for vaccinations and vaccine monitoring](#)
- [27. Measles vaccination summary](#)
- [28. Calculating the number of teams needed for vaccination](#)
- [29. Vaccination team member roles](#)
- [30. Job description, campaign medical supervisor](#)
- [31. Job description, campaign logistics supervisor](#)
- [32. Stock card](#)
- [33. Delivery form for vaccines and vaccination supplies](#)
- [34. Vaccine preparation and storage during mass vaccination campaigns](#)
- [35. Vaccination team observation/supervision grid](#)

[37. Module equipment for one vaccination team](#)

[38. Module equipment for one supervision team](#)

[39. Monitoring distribution and consumption of vaccines and medical supplies](#)

[40. Vehicle and fuel monitoring](#)

[42. Cold chain failure report](#)

[43. Severe allergic reaction to a vaccine](#)

[44. Individual notification form for AEFI with measles vaccine](#)

[45. Summary table of AEFI with measles vaccine](#)

[47. Reporting form for AEB during a vaccination campaign](#)

2. Register of measles samples

[Register of measles samples.doc](#)

3. Request form for laboratory diagnosis of measles

[Request form for laboratory diagnosis of measles.doc](#)

5. Register of measles cases

[Register of measles cases.doc](#)

6. Measles surveillance

[Measles surveillance.xls](#)

8. Measles inpatient unit organization-example

[Measles inpatient unit organization-example.doc](#)

9. Estimating needs - Measles treatments

[Estimating needs - Measles treatments.xls](#)

10. Donation form - examples

[Donation form - examples.doc](#)

11. Treatment availability monitoring

[Treatment availability monitoring.xls](#)

13. Case management

[Case management.pdf](#)

14. Plan rehydration WHO

[Plan rehydration WHO.pdf](#)

17. Example of vaccination campaign timetable

[Example of vaccination campaign timetable.doc](#)

18. Estimating needs - Vaccines and injection supplies

[Estimating needs - Vaccines and injection supplies.xls](#)

20. Cold chain evaluation/inventory

[Cold chain evaluation-inventory.doc](#)

21. Cold chain equipment technical sheets

[Cold chain equipment technical sheets.pdf](#)

22. Temperature monitoring form

[Temperature monitoring form.pdf](#)

23. Estimating needs - Freezing capacity for a vaccination campaign

[Estimating needs - Freezing capacity for a vaccination campaign.xls](#)

26. Tally sheet for vaccinations and vaccine monitoring

[Tally sheet for vaccinations and vaccine monitoring.pdf](#)

27. Measles vaccination summary

[Measles vaccination summary.xls](#)

28. Calculating the number of teams needed for vaccination

[Calculating the number of teams needed for vaccination.xls](#)

29. Vaccination team member roles

[Vaccination team member roles.doc](#)

30. Job description, campaign medical supervisor

[Job description, campaign medical supervisor.doc](#)

31. Job description, campaign logistics supervisor

[Job description, campaign logistics supervisor.doc](#)

32. Stock card

[Stock card.pdf](#)

33. Delivery form for vaccines and vaccination supplies

[Delivery form for vaccines and vaccination supplies.doc](#)

34. Vaccine preparation and storage during mass vaccination campaigns

[Vaccine preparation and storage during mass vaccination campaigns.pdf](#)

35. Vaccination team observation/supervision grid

[Vaccination team observation/supervision grid.pdf](#)

37. Module equipment for one vaccination team

[Module Equipment for one vaccination team.doc](#)

38. Module equipment for one supervision team

[Module Equipment for one supervision team.doc](#)

39. Monitoring distribution and consumption of vaccines and medical supplies

[Monitoring distribution and consumption of vaccines and medical supplies.xls](#)

40. Vehicle and fuel monitoring

[Vehicle and fuel monitoring.doc](#)

42. Cold chain failure report

[Cold chain failure report.pdf](#)

43. Severe allergic reaction to a vaccine

[Severe allergic reaction to a vaccine.pdf](#)

44. Individual notification form for AEFI with measles vaccine

[Individual notification form for AEFI with measles vaccine.pdf](#)

45. Summary table of AEFI with measles vaccine

[Summary table of AEFI.doc](#)

47. Reporting form for AEB during a vaccination campaign

[Reporting form for AEB during a vaccination campaign.pdf](#)

Film: Organising an emergency mass vaccination campaign

[1 - Intervention methods](#)

[2 - Preparation of a campaign](#)

[3 - Resources required](#)

[4 - Practical planning](#)

[5 - The day of vaccination](#)

[6 - Vaccination campaign evaluation](#)

In addition to very thorough organisation, a mass emergency vaccination campaign requires substantial human, material and financial means. The aim is to vaccinate a large number of people in a short period of time. This film is a practical tool for training field volunteers and health personnel who will be involved in a vaccination campaign.

1 - Intervention methods

2 - Preparation of a campaign

3 - Resources required

4 - Practical planning

5 - The day of vaccination

6 - Vaccination campaign evaluation

